



NINGBO CONIC ELEVATOR CO., LTD.

Corporate Address: Dongwangli Building, Yinzhou District, Ningbo City, Zhejiang Province, China

Factory Address: Wujiang District, Suzhou City, Jiangsu Province, China

Phone: +86-057455681351

Mail: info@nbconic.com

WWW.NBCONIC.COM



ENTERPRISE WEBSITE

The printed products are for reference only the company has the right change the designs and specifications of the products at any time, the information contained in the printed does products does not constitute any express or implied guarantees or commitment for the products and its applicability ,merchantability, and quality of special purposes, or any terms of procurement agreement.



 Passenger Elevator

 Hospital Elevator

 Escalator / Moving walk

 Villa Elevator

 Freight Elevator

 Stair Elevator

 Observation Elevator

 Car Elevator

A large iceberg floats in a clear blue ocean under a bright blue sky with scattered white clouds. The visible tip of the iceberg is a small, snow-capped mountain peak. The vast majority of the iceberg is submerged underwater, appearing as a complex, jagged structure of ice. The water is a deep, clear blue, and the sky is a lighter, vibrant blue. The overall scene is serene and emphasizes the hidden nature of the submerged part of the iceberg.

**WHAT WE CAN SEE IS ONLY
A SMALL PART OF ELEVATOR**

CABIN

COP

LOP

**NUMEROUS OTHER ESSENTIAL
COMPONENTS REMAIN**

HIDDEN FROM OUR VIEW

AND THESE INVISIBLE ELEMENTS
CAN ENSURE THE ELEVATOR
OPERATES SAFELY
AND EFFICIENTLY



NINGBO CONIC ELEVATOR CO., LTD.

CORPORATE INTRODUCTION

NINGBO CONIC ELEVATOR CO., LTD located at Yinzhou District, Ningbo, Zhejiang Province.

Ningbo CONIC Elevator Company is a leading provider of complete elevator systems, specializing in the design, manufacturing, and export of elevators and escalators for commercial, residential, and industrial applications.

We are Sino Foreign Invested Company, we have grown to become one of the largest and most respected elevator manufacturers in the world. Our success is built on our commitment to quality, innovation, and customer satisfaction. We use only the finest materials and components, and we employ a highly skilled workforce of engineers, technicians, and craftsmen to ensure that our products meet the highest standards of safety, reliability, and performance.

Ningbo CONIC Elevator Manufacturing Company, we understand that elevators are a critical component of modern infrastructure, and we take our responsibility to provide safe and reliable elevators very seriously. That's why we offer a complete range of elevators, from simple traction elevators for residential use to high-speed, high-capacity elevators for commercial and industrial applications. And we are constantly seeking new ways to improve our products and services, so that we can provide our customers with the best possible solutions for their needs.

If you're looking for a partner that can provide you with the best elevators and escalators, look no further than Elevator Manufacturing Company. Contact us today to learn more about how we can help you meet your needs.

Main products are: Passenger Elevator, Observation Elevator, Home Elevator, Hospital Elevator, Freight Elevator, Car Elevator, Stair Elevator, Escalator, Moving Walk.



SERVICE PROVIDERS OF GLOBAL TRUST PROFESSIONAL ELEVATOR MANUFACTURER

ENJOY THE EXPERIENCE WITH PEACE OF MIND

The permanent magnet synchronous gearless traction machine has developed a new generation of energy-saving elevators. Its core technology successfully developed based on the concept of environmental protection represents the future development direction of elevators. Energy-saving, space-saving, lower building construction costs and elevator operating costs are the biggest features of this core technology leading the industry. And it completely solves the environmental pollution problem caused by the oil leakage of the traditional traction machine, and meets the maintenance-free and environmental protection requirements of the motor.

Maximum energy efficiency rating

We have been committed to researching and developing more energy-efficient elevator solutions to help customers save costs. Our energy saving is mainly through three ways: the host, car equipment, and control system.

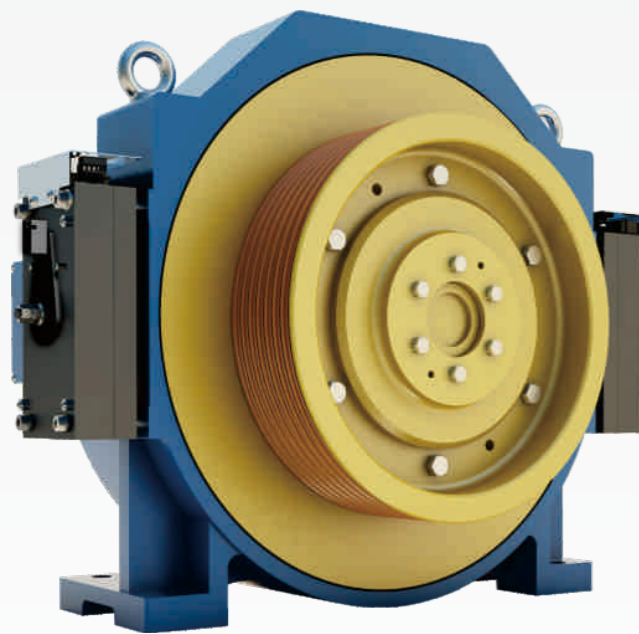
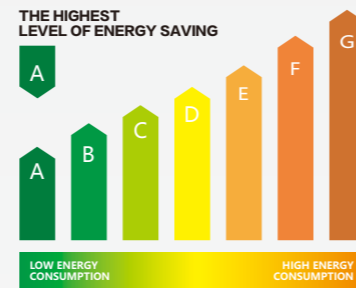

GEARLESS TRACTION MACHINE



WITH GEAR TRACTION MACHINE



Light curtain

A full range of infrared light curtain protection barrier, effectively monitoring the elevator entrance area objects, safety performance is high, the more freedom to go in and out.

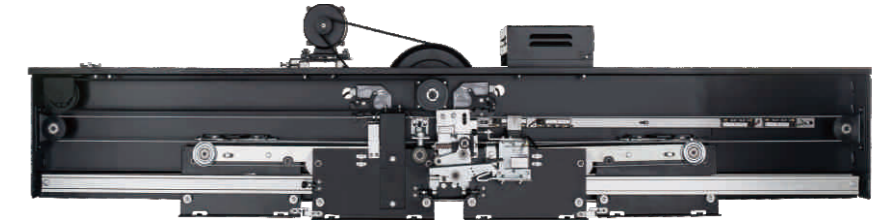

VVVF variable frequency asynchronous door operator

CONIC elevator applies the advanced VVVF variable voltage and variable frequency control technology to the elevator door operator system so as to ensure the smooth elevator door and quiet switch. What is more, the self-learning door load detector increases the sensitivity of the elevator door switching on/off. It monitors the variation of elevator door load on every floor. Automatically rectifying the most appropriate open/shut speed in every floor so as to guarantee the security and reliability.



If elevator exceeds standard speed limit, speed governor acts and cuts off safety loop to ensure elevator stop. If elevator exceeds standard speed, safety tongs acts through linkage of speed governor It thus ensures elevator safety brake It applies hydraulic buffer. It can absorb elevator abnormal impact energy to maximum degree It thus guarantees safety of vast passengers.

Adopt the most advanced energy-saving technology to minimize energy consumption during operation. Economical and durable operation mode, which effectively saves operating costs and maintenance costs.

FULL COMMITMENT TO SAFETY

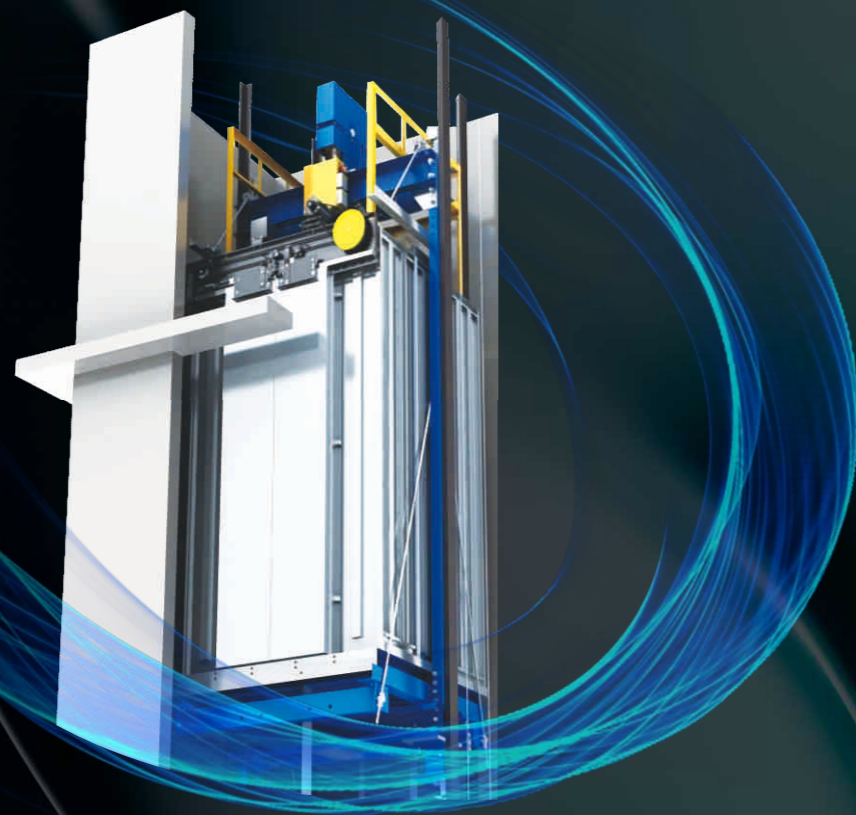

Super stall safety protection system

When elevator over-speed, fall-down etc. take place, if electrical contactor action can not stop the elevator and speed attains certain value, speed governor then executes mechanical action. It triggers safety tongs to clamp the guiderail and brake the elevator car.

Landing / car door safety protection system

If it detects any obstacle at door-closing zone, door re-opens again. Meanwhile, after landing door and car door are closed, elevator can then start again. After all the doors at various floors are closed, elevator can start up / down motion.

Electrical safety protection system

Electrical safety protection switches of various elevator safety protection system are of series connection. Only one switch action can break the safety protection circuit and stop the elevator.

Safety against mechanical damage

In order to prevent from accidental mechanical damage, safety devices such as speed governor etc., set warning mark and guardrail at nearby places.

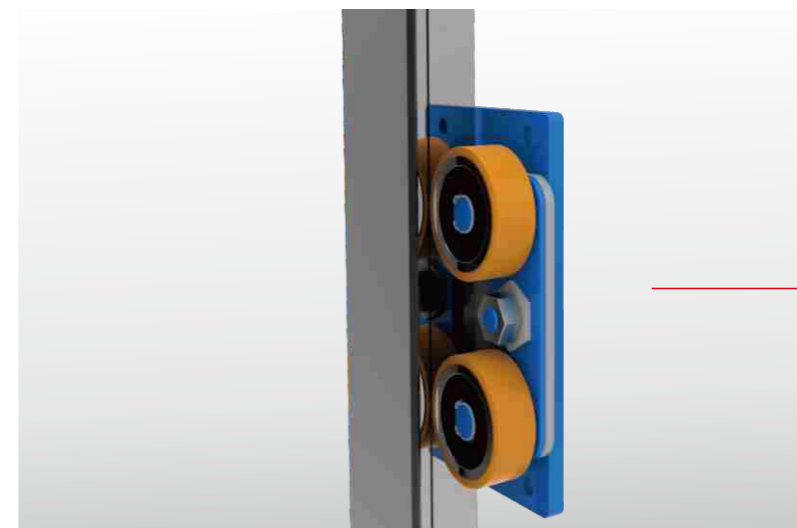
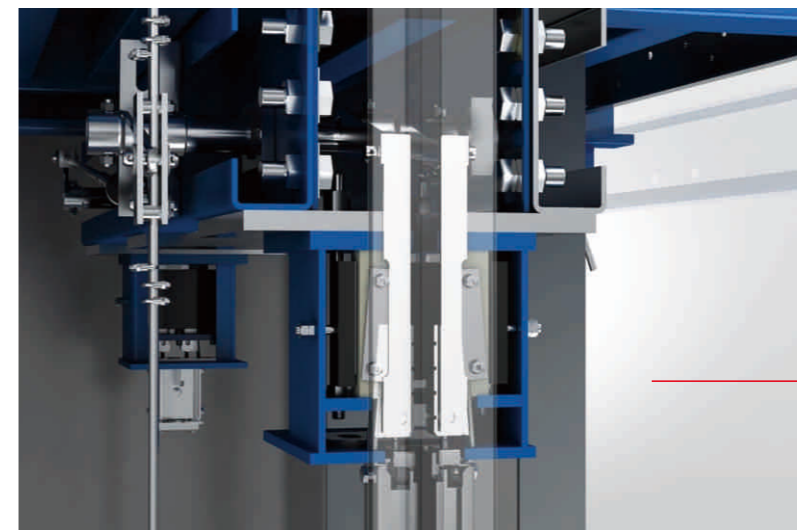
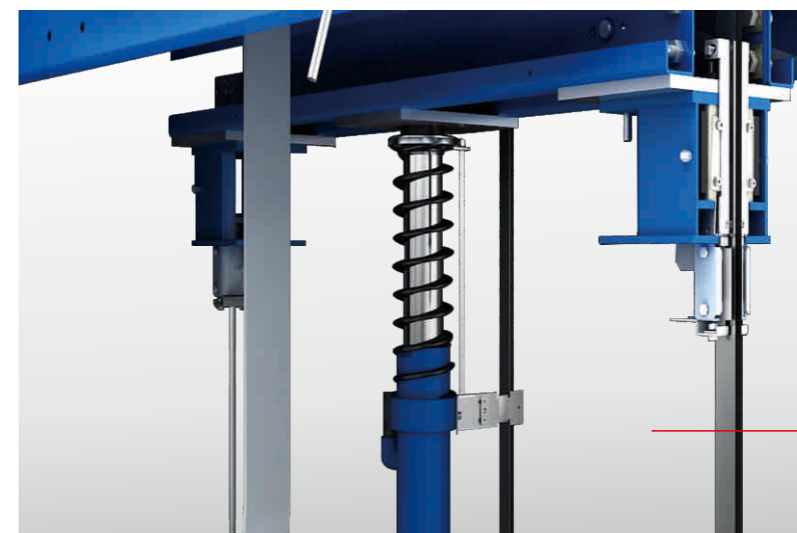
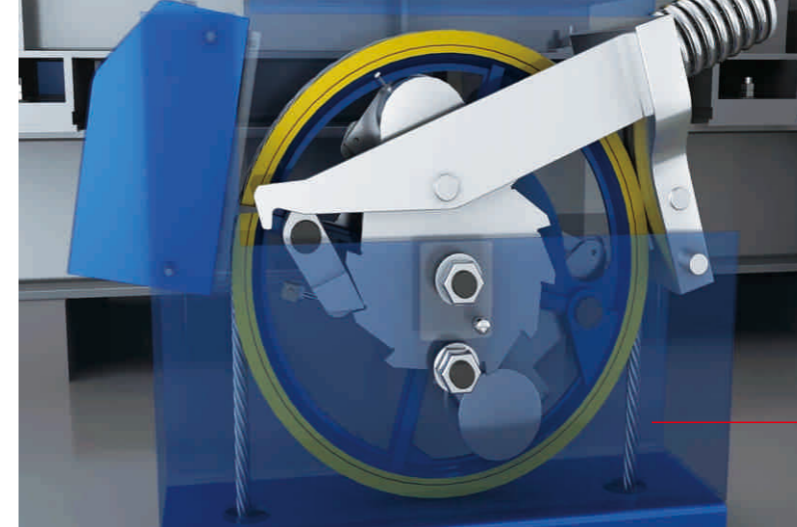

OVER SPEED GOVERNOR

When the elevator exceeds the standard limit speed, the speed limiter will cut off the safety circuit to ensure that the elevator stops running, and the safety gear will be lifted mechanically to stop the car on the guide rail.



BUFFER

It can absorb the abnormal impact energy of the elevator to the greatest extent and ensure the safety of elevator passengers.



SAFETY GEAR

When the elevator exceeds the standard speed, the safety gear is actuated by the linkage of the speed limiter to ensure the safe stop of the elevator.

ROLLER GUIDE SHOES

Rolling friction is used instead of sliding friction, which reduces friction loss, reduces vibration and noise during operation, and improves ride comfort.

**WISDOM
CREATE THE FUTURE**

CONTROL CABINET

DUAL 32-BIT INTELLIGENT FULLCOMPUTER CONTROL SYSTEM

The elevator control system is an integrated product designed specifically for elevator control systems. The "integrated" control technology is suitable for the permanent magnet synchronous elevator main engine. In simple terms, it integrates the elevator inverter and the control board, saving electrical components and control cabinet space, reducing costs, and at the same time controlling the operation and maintenance of the cabinet. Correspondingly, it becomes simple.

Load adaptive system

The IGBT switching frequency of up to 16KHz and the 360° fully enclosed car noise reduction design enable passengers to obtain a quiet ride experience.

Multiple vibration reduction adaptive system (>1.0m/s)

The main engine, rope fastening car, car top, spring and rubber are used for multiple vibration damping, which brings perfect up and down enjoyment to passengers.

Top-grade door machine system

Highly integrated micro-computer network control system instantly finishes data operation. Serial data transmission orderly and accurately transmits every message. It enhances accurate and reliable signal control.

24 hours remote monitoring (paid option)

Through the wireless communication module, 24-hour live monitoring of the elevator operation status in the remote monitoring center can realize automatic fault alarm, real-time guidance and troubleshooting, and ensure that the elevator can resume operation quickly.

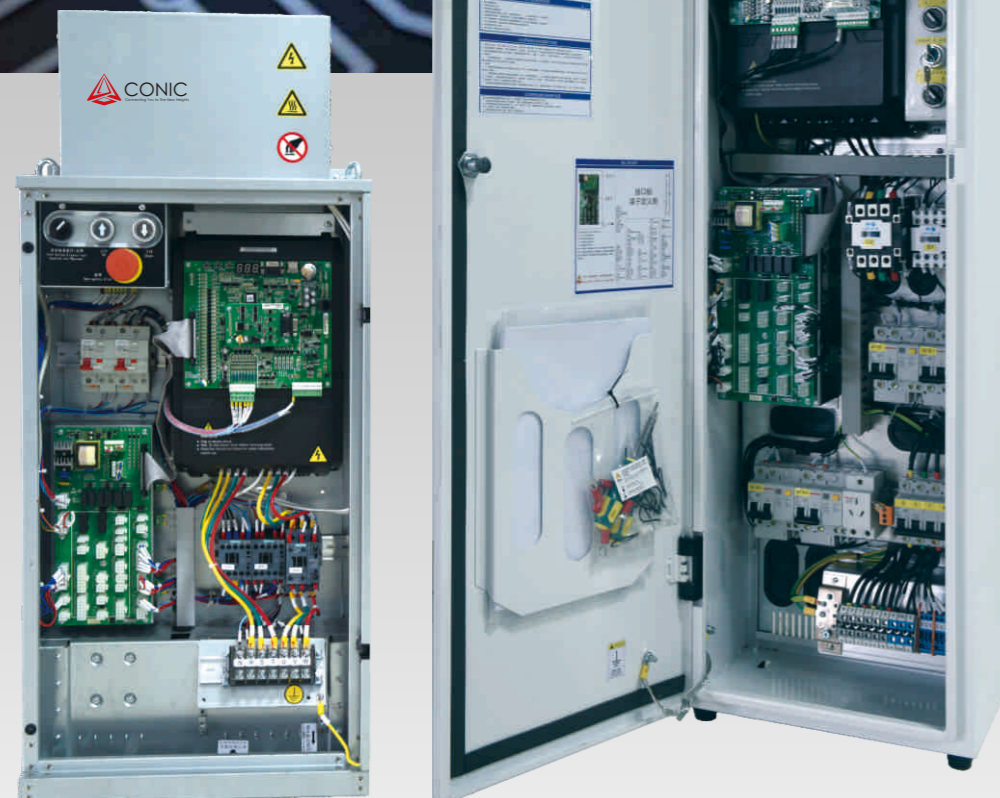

SMALL MACHINE ROOM PASSENGER ELEVATOR

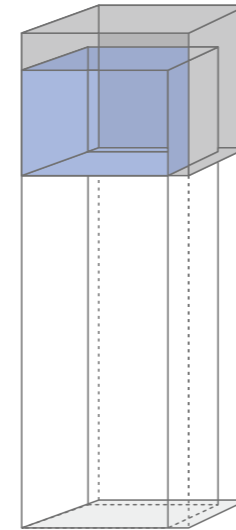
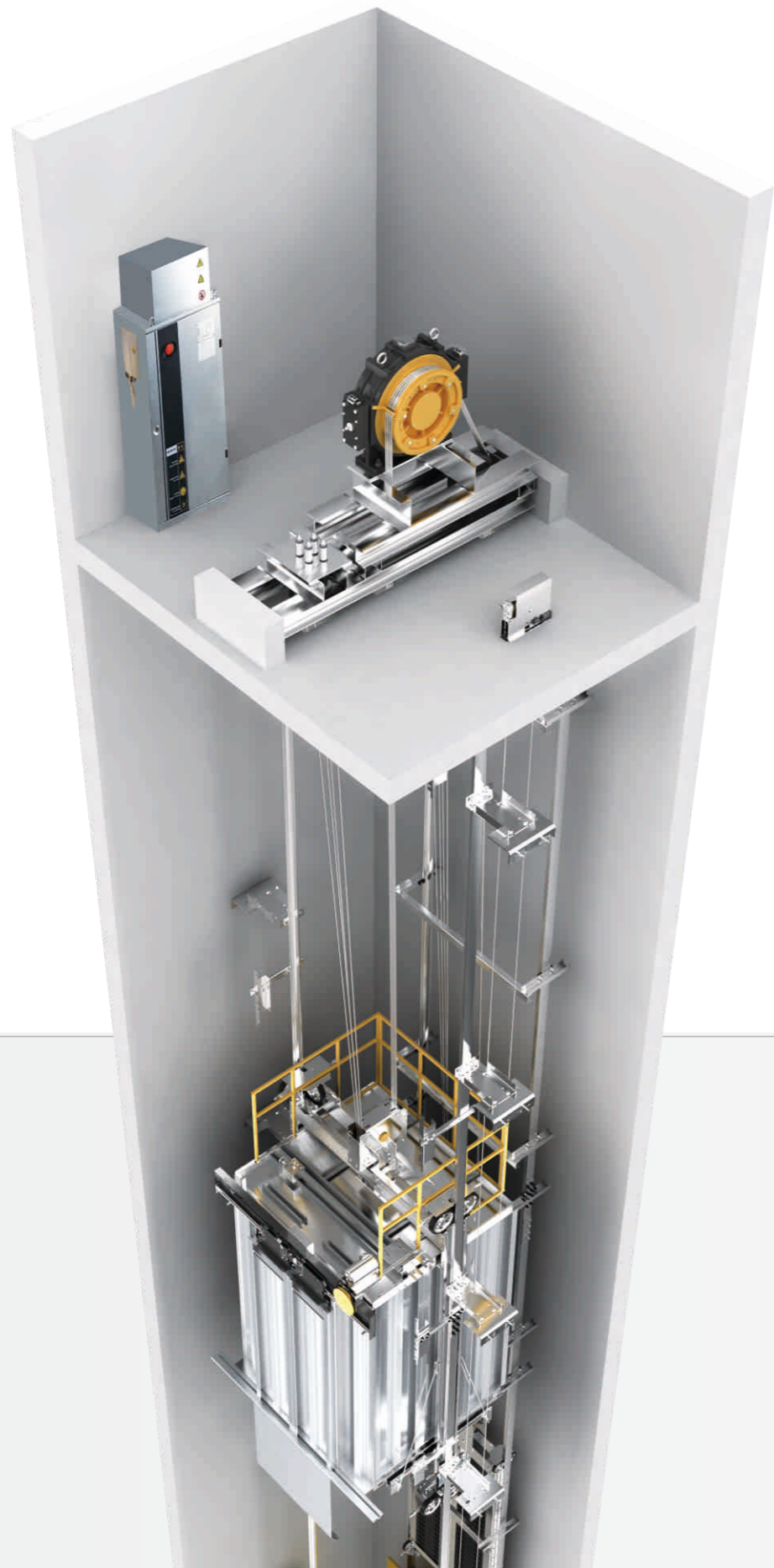

Optimized space of small machine room design reduces the construction cost.

The net height of the top floor of the traditional elevator

The top floor of the small computer room height reduction

Reduce the area of machine room

56%

Save room space and release building space
 Outstanding energy-saving effect, saving the cost of use
 Eliminate oil pollution and make the environment cleaner

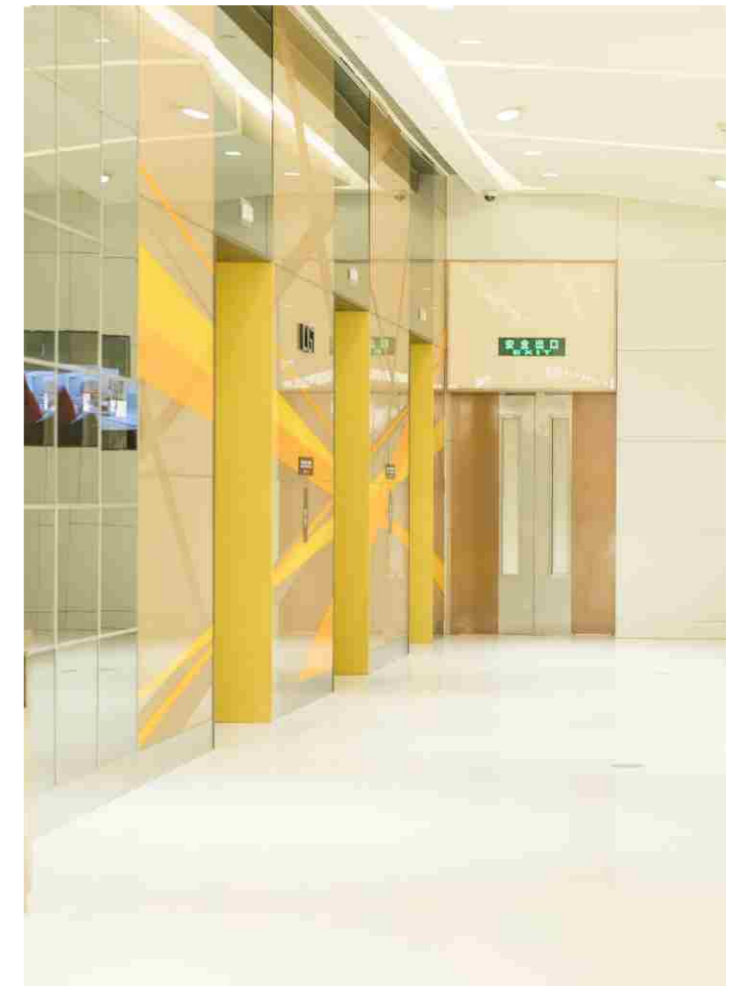

Inner / outer perfection for more superior quality

Today with flourishing development in the building industry, elevator functions indispensably. High quality passenger elevator integrates the excellent properties and comfortable travel into one. It is your best choice in residence, commercial building, office building, business center, hotel, restaurant etc.

Applying fields



Residential



Office building

Reasonable civil engineering arrangement

Realize consistent size between machine room and well, reduce machine room height by 250mm, reserving larger construction space.

MACHINE ROOMLESS PASSENGER ELEVATOR

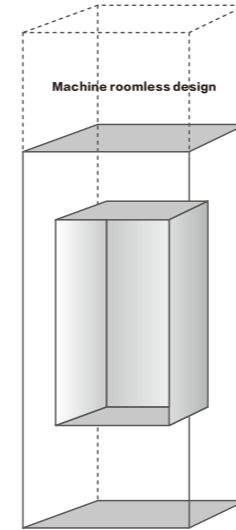
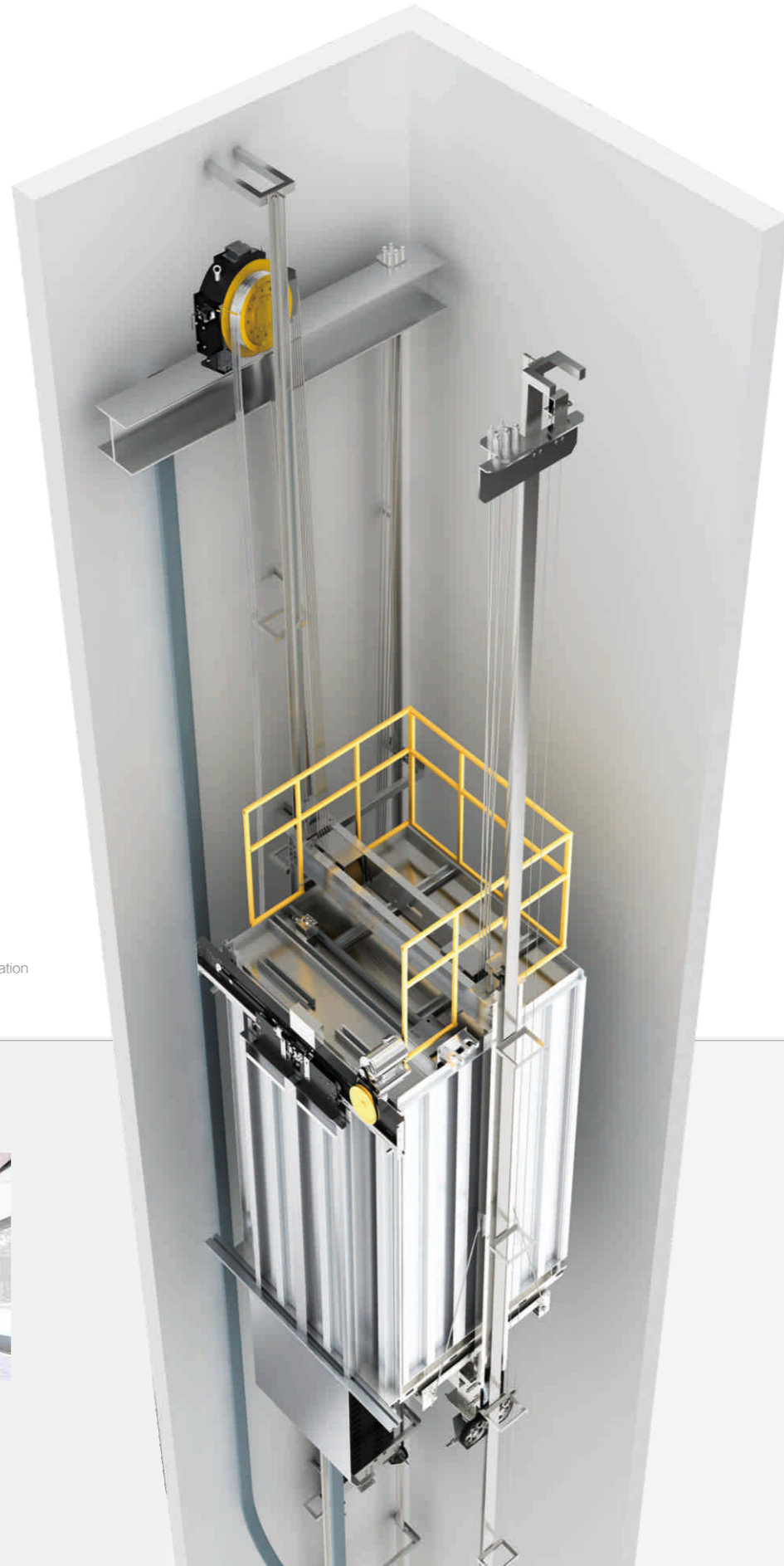

Machine roomless design
Significantly increase the building area

Achieving 100% utilization of building area

100%

Free up machine room space and expand architectural design
Prevent electromagnetic interference and avoid electronic radiation
Lower operating noise, creating a quiet space

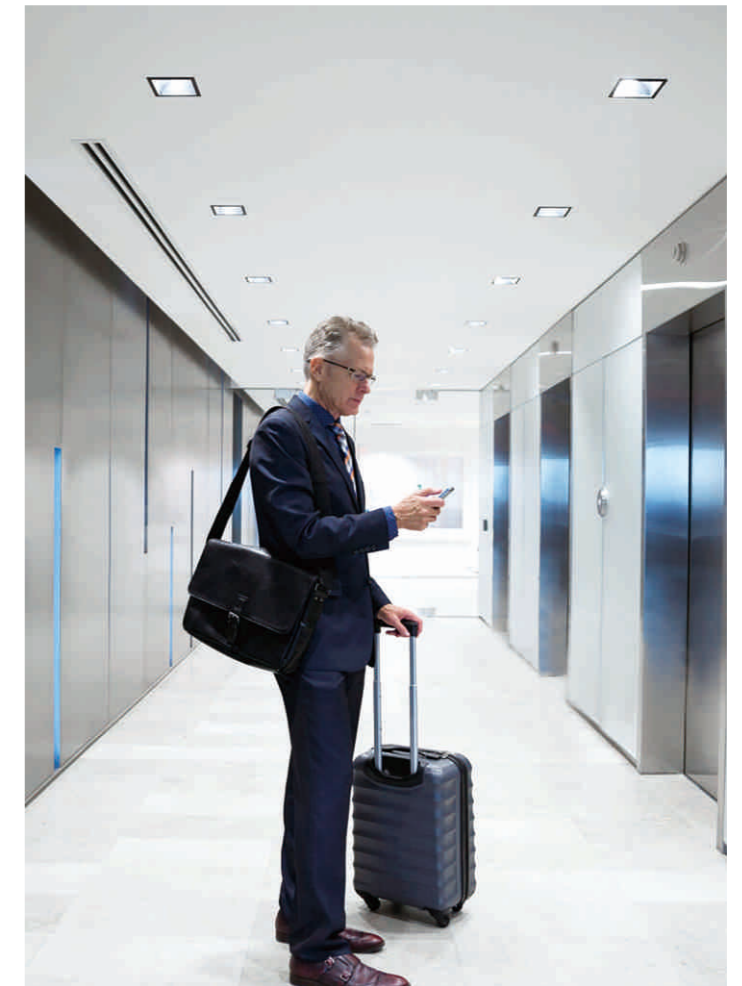
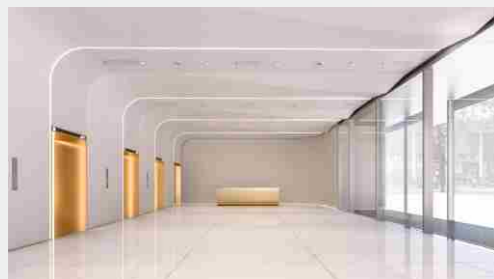

Easy to integrate enhance the building value

With machine room less structure, control cabinet and traction are placed in the shaft flexibly. It saves construction area and with artistic and simple shape, which reduces comprehensive construction cost and leaves design space for architects and developers.

Applying fields



Residential



Business building

Low energy consumption space-saving

It is low energy consumption-based. It fully considers building space's utilization rate and cost. Using compact layout and flexible design style and cleverly integrating all kinds of buildings, it is the first choice for modern individualized buildings.

GENERAL CABIN DESIGN OPTIONAL

HAIRLINE CAR

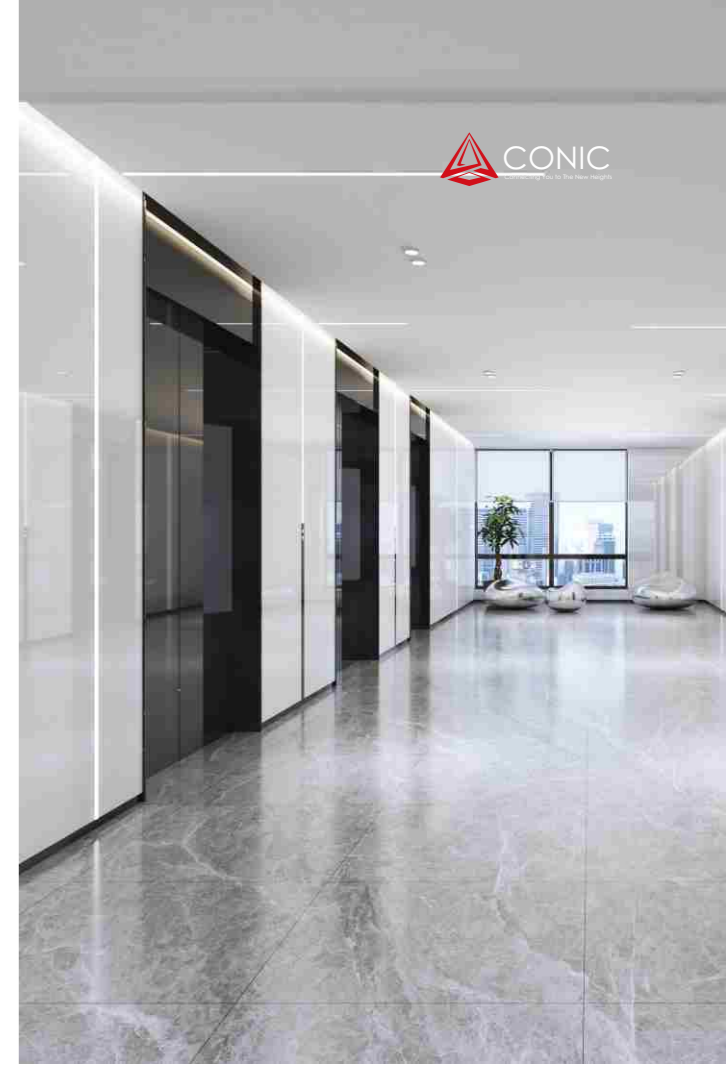

CON-C1

Standard

Ceiling: Hairline stainless steel, LED lighting
Cabin wall: Hairline stainless steel
Floor: PVC (marble optional)



Hairline stainless steel
CON-DOR-H1



Scan the QR code
watch the car



CON-COP-1

304SS Hairline
COP faceplate size: 1370*180
install size: 1330*155



CON-LOP-1

304SS Hairline

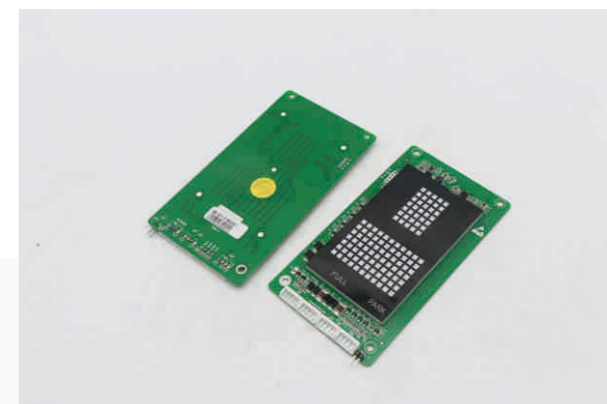

LOP display

LOP display : DOT display, red white orange optional

REGULAR CABIN DESIGN OPTIONAL

MIRROR ETCHING

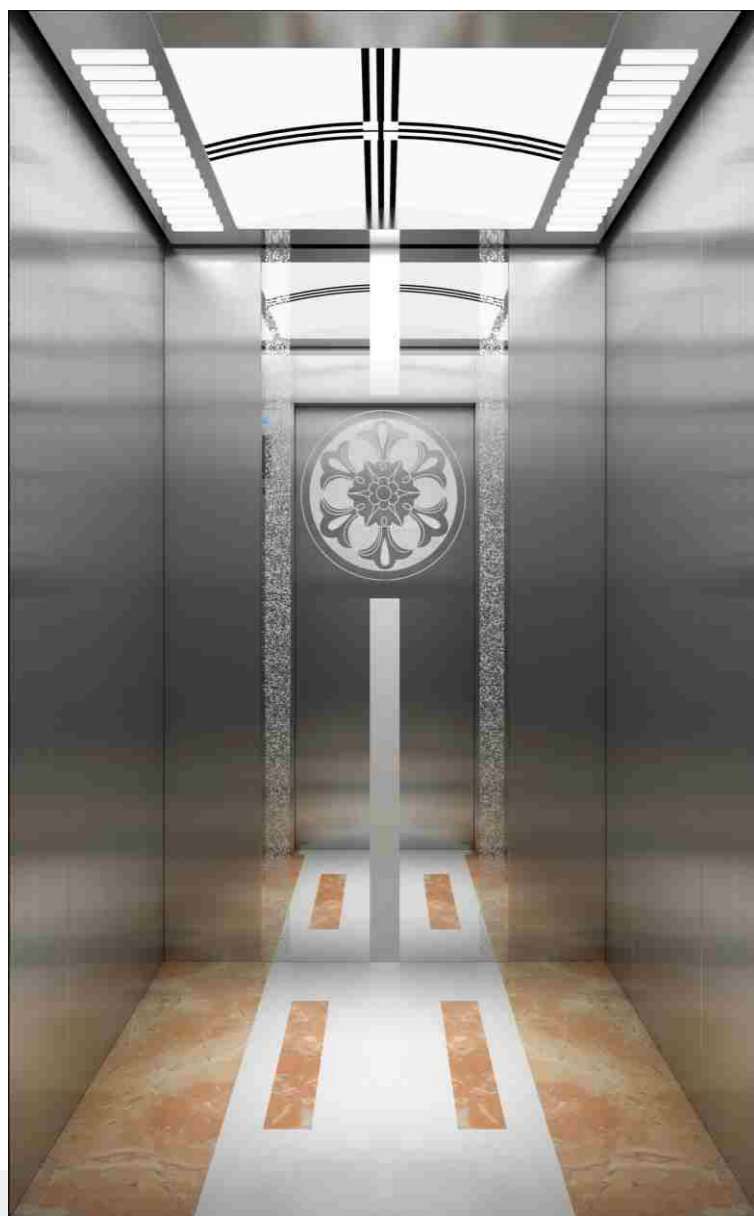

CON-C2

Optional

Ceiling: Mirror frame, transparent lamp posts, LED lights
Cabin wall: Mirror etching
Floor: PVC (marble optional)



Mirror stainless steel

CON-DOR-M1



Scan the QR code
watch the car



CON-COP-2

304SS Mirror
COP faceplate size: 1370*180
Install size: 1330*155



CON-LOP-2

Faceplate 304SS
Side aluminium

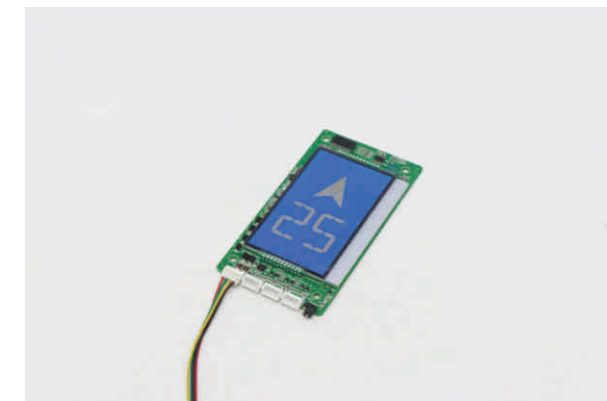

LOP display

LOP display : LCD display, blue black background optional



REGULAR CABIN DESIGN OPTIONAL



CON-C3

Optional

Ceiling: Hairline stainless steel frame, acrylic arch, LED lights
Cabin wall: Hairline stainless steel on both sides, hairline stainless steel on the rear wall combined with mirror etching
Floor: PVC (marble optional)

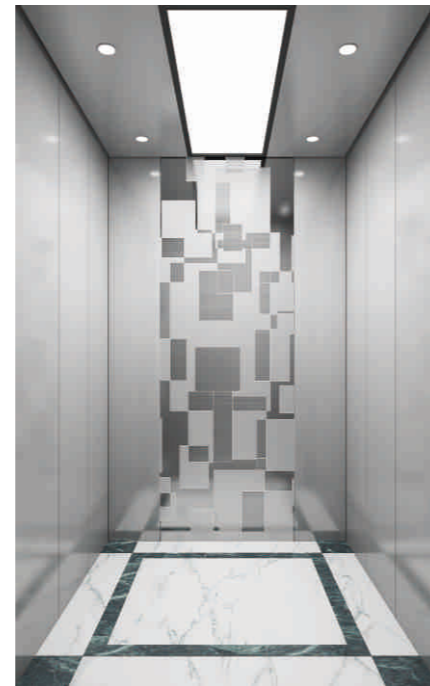

CON-C4

Optional

Ceiling: Hairline stainless steel, acrylic lighting, LED lights
Cabin wall: Hairline stainless steel on both sides, hairline stainless steel on the rear wall combined with mirror etching
Floor: PVC (marble optional)

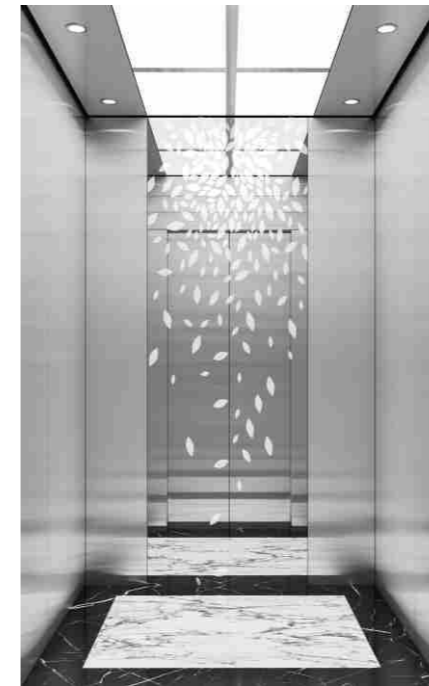

CON-C7

Optional

Ceiling: Hairline stainless steel, acrylic lighting, LED lights
Cabin wall: Hairline stainless steel on both sides, hairline stainless steel on the rear wall combined with mirror etching
Floor: PVC (marble optional)



CON-C8

Optional

Ceiling: Hairline stainless steel, acrylic lighting, LED lights
Cabin wall: Hairline stainless steel on both sides, hairline stainless steel on the rear wall combined with mirror etching
Floor: PVC (marble optional)



CON-C5

Optional

Ceiling: Hairline stainless steel frame, acrylic arch, LED lights
Cabin wall: Hairline stainless steel on both sides, hairline stainless steel on the rear wall combined with mirror etching
Floor: PVC (marble optional)

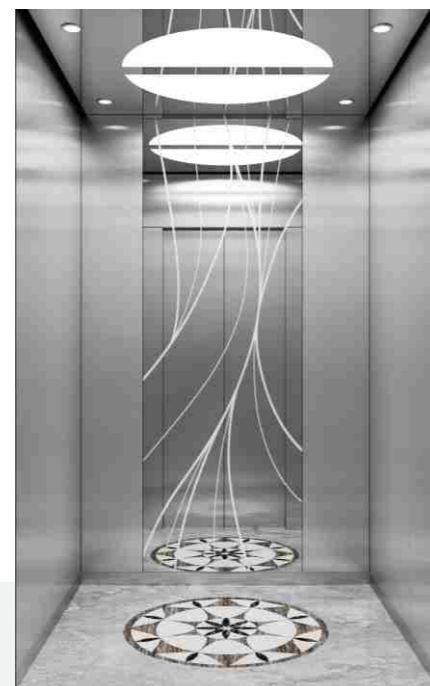

CON-C6

Optional

Ceiling: Mirror stainless steel, acrylic lighting, LED lights
Cabin wall: Hairline stainless steel on both sides, hairline stainless steel on the rear wall combined with mirror etching
Floor: PVC (marble optional)



CON-C9

Optional

Ceiling: Mirror stainless steel, acrylic lighting, LED lights
Cabin wall: Hairline stainless steel on both sides, hairline stainless steel on the rear wall combined with mirror etching
Floor: PVC (marble optional)



CON-C10

Optional

Ceiling: Mirror stainless steel, acrylic lighting, LED lights
Cabin wall: Hairline stainless steel on both sides, hairline stainless steel on the rear wall combined with mirror etching
Floor: PVC (marble optional)

STANDARD CABIN DESIGN OPTIONAL

MIRROR ETCH



CON-C11 Optional

Ceiling: Mirror frame, transparent lamp posts, LED lights
 Cabin wall: Mirror etching on 3 sides
 Floor: PVC (marble optional)



CON-COP-3

COP 304SS Hairline, LOP 304SS Mirror Glass optional
 COP faceplate size: 1370*180, install size: 1330*155
 COP display: Photo display
 LOP display: DOT LCD display optional



Scan the QR code watch the car



CON-LOP-3



CON-LOP-4



CON-C12 Optional

Ceiling: Hairline stainless steel, acrylic lighting, LED lights
 Cabin wall: Mirror etching on 3 sides
 Floor: PVC (marble optional)



CON-C13 Optional

Ceiling: Mirror stainless steel, acrylic lighting, LED lights
 Cabin wall: Mirror etching on 3 sides
 Floor: PVC (marble optional)



CON-C14 Optional

Ceiling: Mirror stainless steel, acrylic lighting, LED lights
 Cabin wall: Mirror etching on 3 sides
 Floor: PVC (marble optional)

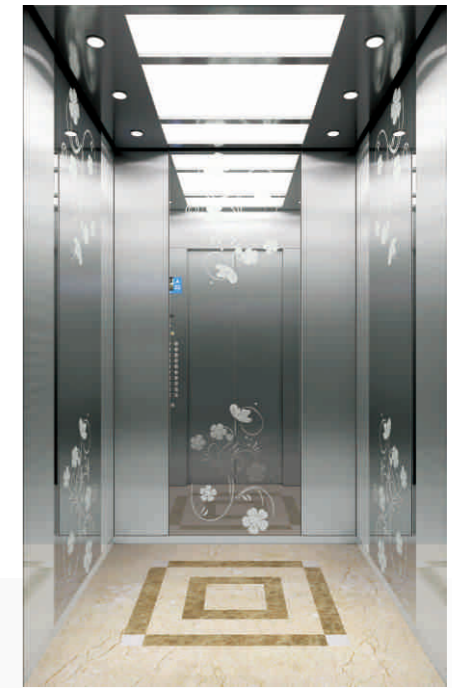

CON-C15 Optional

Ceiling: Mirror stainless steel, acrylic lighting, LED lights
 Cabin wall: Mirror etching on 3 sides
 Floor: PVC (marble optional)



STANDARD CABIN DESIGN OPTIONAL



CON-C16 Optional

Ceiling: Mirror stainless steel, acrylic lighting, LED lights
 Cabin wall: Mirror etching on 3 sides
 Floor: PVC (marble optional)



CON-C17 Optional

Ceiling: Mirror stainless steel, acrylic lighting, LED lights
 Cabin wall: Mirror etching on 3 sides
 Floor: PVC (marble optional)



CON-C20 Optional

Ceiling: Hairline stainless steel, acrylic lighting, LED lights
 Cabin wall: Mirror etching on 3 sides
 Floor: PVC (marble optional)



CON-C21 Optional

Ceiling: Mirror stainless steel, acrylic lighting, LED lights
 Cabin wall: Mirror etching on 3 sides
 Floor: PVC (marble optional)



CON-C18 Optional

Ceiling: Hairline stainless steel, acrylic lighting, LED lights
 Cabin wall: Mirror etching on 3 sides
 Floor: PVC (marble optional)



CON-C19 Optional

Ceiling: Mirror stainless steel, acrylic lighting, LED lights
 Cabin wall: Mirror etching on 3 sides
 Floor: PVC (marble optional)



CON-C22 Optional

Ceiling: Hairline stainless steel, acrylic lighting, LED lights
 Cabin wall: Mirror etching on 3 sides
 Floor: PVC (marble optional)

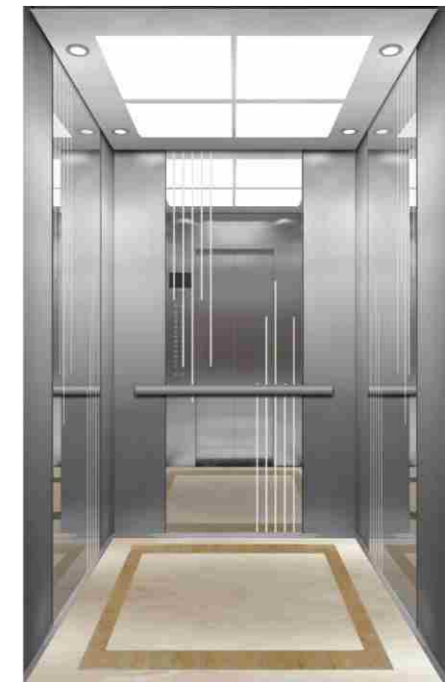

CON-C23 Optional

Ceiling: Hairline stainless steel, acrylic lighting, LED lights
 Cabin wall: Mirror etching on 3 sides
 Floor: PVC (marble optional)

STANDARD CABIN DESIGN OPTIONAL



CON-C24 Optional

Ceiling: Hairline stainless steel, acrylic lighting, LED lights
Cabin wall: Mirror etching on 3 sides
Floor: PVC (marble optional)



CON-C25 Optional

Ceiling: Mirror stainless steel, acrylic lighting, LED lights
Cabin wall: Mirror etching on 3 sides
Floor: PVC (marble optional)



CON-C28 Optional

Ceiling: Mirror stainless steel, acrylic lighting, LED lights
Cabin wall: Mirror etching on 3 sides
Floor: PVC (marble optional)



CON-C29 Optional

Ceiling: Hairline stainless steel, acrylic lighting, LED lights
Cabin wall: Mirror etching on 3 sides
Floor: PVC (marble optional)



CON-C26 Optional

Ceiling: Hairline stainless steel, acrylic lighting, LED lights
Cabin wall: Mirror etching on 3 sides
Floor: PVC (marble optional)



CON-C27 Optional

Ceiling: Mirror stainless steel, acrylic lighting, LED lights
Cabin wall: Mirror etching on 3 sides
Floor: PVC (marble optional)



CON-C30 Optional

Ceiling: Hairline stainless steel, acrylic lighting, LED lights
Cabin wall: Mirror etching on 3 sides
Floor: PVC (marble optional)



CON-C31 Optional

Ceiling: Hairline stainless steel, acrylic lighting, LED lights
Cabin wall: Mirror etching on 3 sides
Floor: PVC (marble optional)

STANDARD CABIN DESIGN OPTIONAL



CON-C32 Optional

Ceiling: Mirror stainless steel, acrylic lighting, LED lights
 Cabin wall: Mirror etching on 3 sides
 Floor: PVC (marble optional)



CON-C33 Optional

Ceiling: Hairline stainless steel, acrylic lighting, LED lights
 Cabin wall: Mirror etching on 3 sides
 Floor: PVC (marble optional)



CON-C36 Optional

Ceiling: Hairline stainless steel, acrylic lighting, LED lights
 Cabin wall: Mirror etching on 3 sides
 Floor: PVC (marble optional)



CON-C37 Optional

Ceiling: Mirror stainless steel, acrylic lighting, LED lights
 Cabin wall: Mirror etching on 3 sides
 Floor: PVC (marble optional)



CON-C34 Optional

Ceiling: Hairline stainless steel, acrylic lighting, LED lights
 Cabin wall: Mirror etching on 3 sides
 Floor: PVC (marble optional)



CON-C35 Optional

Ceiling: Hairline stainless steel, acrylic lighting, LED lights
 Cabin wall: Mirror etching on 3 sides
 Floor: PVC (marble optional)



CON-C38 Optional

Ceiling: Mirror stainless steel, acrylic lighting, LED lights
 Cabin wall: Mirror etching on 3 sides
 Floor: PVC (marble optional)



CON-C39 Optional

Ceiling: Mirror stainless steel, acrylic lighting, LED lights
 Cabin wall: Mirror etching on 3 sides
 Floor: PVC (marble optional)

STANDARD CABIN DESIGN OPTIONAL



CON-C40 Optional
 Ceiling: Sprayed steel plate, acrylic
 Cabin wall: Mirror etching on 3 sides
 Floor: PVC (marble optional)



CON-C41 Optional
 Ceiling: Mirror stainless steel, acrylic lighting, LED lights
 Cabin wall: Mirror etching on 3 sides
 Floor: PVC (marble optional)



CON-C44 Optional
 Ceiling: Steel plate spray, acrylic lamp, LED lights
 Cabin wall: Mirror etching on 3 sides
 Floor: PVC (marble optional)



CON-C45 Optional
 Ceiling: Stainless steel mirror, acrylic lighting, LED lights
 Cabin wall: Mirror etching on 3 sides
 Floor: PVC (marble optional)



CON-C42 Optional
 Ceiling: Hairline stainless steel, acrylic
 Cabin wall: Mirror etching on 3 sides
 Floor: PVC (marble optional)



CON-C43 Optional
 Ceiling: Steel plate spray, acrylic lamp, LED lights
 Cabin wall: Mirror etching on 3 sides
 Floor: PVC (marble optional)



CON-C46 Optional
 Ceiling: Hairline stainless steel, acrylic
 Cabin wall: Mirror etching on 3 sides
 Floor: PVC (marble optional)



CON-C47 Optional
 Ceiling: Hairline stainless steel, acrylic
 Cabin wall: Mirror etching on 3 sides
 Floor: PVC (marble optional)

STANDARD CABIN DESIGN OPTIONAL



CON-C48 Optional

Ceiling: Mirror stainless steel, acrylic lighting, LED lights
 Cabin wall: Mirror etching on 3 sides
 Floor: PVC (marble optional)



CON-C49 Optional

Ceiling: Mirror stainless steel, acrylic lighting, LED lights
 Cabin wall: Mirror etching on 3 sides
 Floor: PVC (marble optional)



CON-C52 Optional

Ceiling: Hairline stainless steel, arched light-transmitting panels, LED lights
 Cabin wall: Mirror etching on 3 sides
 Floor: PVC (marble optional)

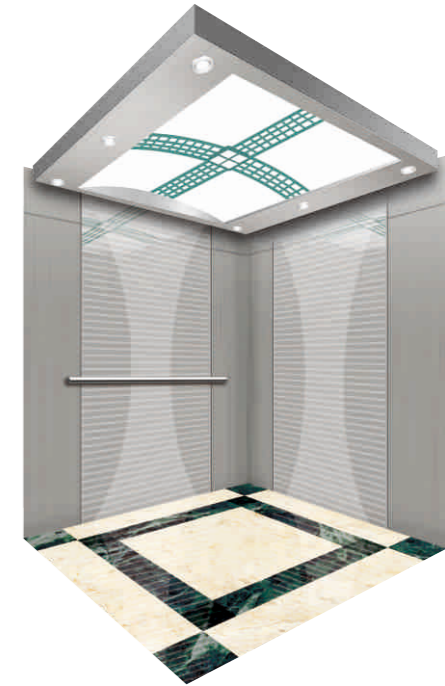

CON-C53 Optional

Ceiling: Hairline stainless steel, acrylic
 Cabin wall: Mirror etching on 3 sides
 Floor: PVC (marble optional)



CON-C50 Optional

Ceiling: Mirror stainless steel, acrylic lighting
 Cabin wall: Mirror etching on 3 sides
 Floor: PVC (marble optional)



CON-C51 Optional

Ceiling: Mirror stainless steel, acrylic lighting
 Cabin wall: Mirror etching on 3 sides
 Floor: PVC (marble optional)



CON-C54 Optional

Ceiling: Stainless steel mirror, acrylic
 Cabin wall: Mirror etching on 3 sides
 Floor: PVC (marble optional)



CON-C55 Optional

Ceiling: Hairline stainless steel, acrylic
 Cabin wall: Mirror etching on 3 sides
 Floor: PVC (marble optional)

STANDARD CABIN DESIGN OPTIONAL



CON-C56 Optional
 Ceiling: Steel plate spray, acrylic lamp, LED lights
 Cabin wall: Mirror etching on 3 sides
 Floor: PVC (marble optional)



CON-C57 Optional
 Ceiling: Mirror stainless steel, acrylic lighting
 Cabin wall: Mirror etching on 3 sides
 Floor: PVC (marble optional)



CON-C60 Optional
 Ceiling: Hairline stainless steel, arched light-transmitting panels, LED lights
 Cabin wall: Mirror etching on 3 sides
 Floor: PVC (marble optional)



CON-C61 Optional
 Ceiling: Mirror stainless steel, acrylic lighting
 Cabin wall: Mirror etching on 3 sides
 Floor: PVC (marble optional)



CON-C58 Optional
 Ceiling: Hairline stainless steel, acrylic
 Cabin wall: Mirror etching on 3 sides
 Floor: PVC (marble optional)



CON-C59 Optional
 Ceiling: Mirror stainless steel, acrylic lighting, LED lights
 Cabin wall: Mirror etching on 3 sides
 Floor: PVC (marble optional)



CON-C62 Optional
 Ceiling: Stainless steel mirror, acrylic
 Cabin wall: Mirror etching on 3 sides
 Floor: PVC (marble optional)



CON-C63 Optional
 Ceiling: Hairline stainless steel, acrylic
 Cabin wall: Mirror etching on 3 sides
 Floor: PVC (marble optional)

STANDARD CABIN DESIGN OPTIONAL



CON-C64 Optional
 Ceiling: Mirror stainless steel, acrylic lighting, LED lights
 Cabin wall: Mirror etching on 3 sides
 Floor: PVC (marble optional)



CON-C65 Optional
 Ceiling: Mirror stainless steel, acrylic lighting, LED lights
 Cabin wall: Mirror etching on 3 sides
 Floor: PVC (marble optional)

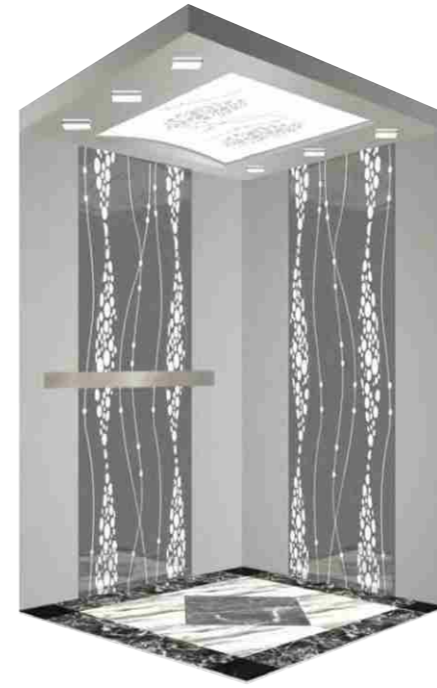

CON-C68 Optional
 Ceiling: Hairline stainless steel, arched light-transmitting panels, LED lights
 Cabin wall: Mirror etching on 3 sides
 Floor: PVC (marble optional)



CON-C69 Optional
 Ceiling: Hairline stainless steel, acrylic lighting, LED lights
 Cabin wall: Mirror etching on 3 sides
 Floor: PVC (marble optional)



CON-C66 Optional
 Ceiling: Hairline stainless steel, acrylic lighting, LED lights
 Cabin wall: Mirror etching on 3 sides
 Floor: PVC (marble optional)



CON-C67 Optional
 Ceiling: Hairline stainless steel, acrylic lighting, LED lights
 Cabin wall: Mirror etching on 3 sides
 Floor: PVC (marble optional)



CON-C70 Optional
 Ceiling: Stainless steel mirror, acrylic lighting, LED lights
 Cabin wall: Mirror etching on 3 sides
 Floor: PVC (marble optional)



CON-C71 Optional
 Ceiling: Mirror stainless steel, acrylic lighting, LED lights
 Cabin wall: Mirror etching on 3 sides
 Floor: PVC (marble optional)

PREMIUM CABIN DESIGN OPTIONAL

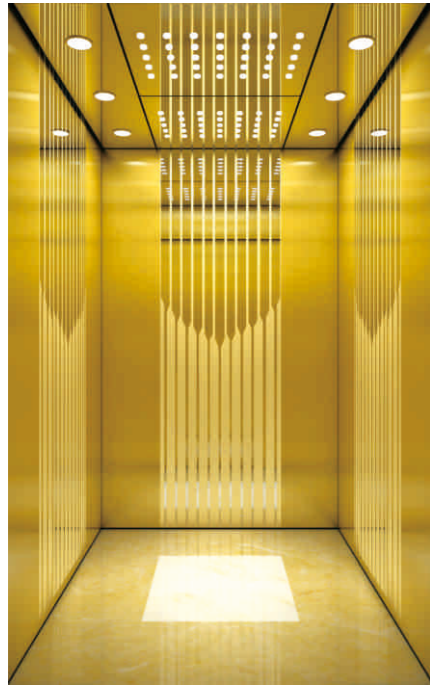

CON-C72 Optional

Ceiling: Titanium mirror frame, acrylic lighting, LED lights
Cabin wall: Three-sided titanium mirror etching
Floor: PVC (marble optional)



CON-C73 Optional

Ceiling: Titanium mirror frame, acrylic lighting, LED lights
Cabin wall: Three-sided titanium mirror etching
Floor: PVC (marble optional)



CON-C76 Optional

Ceiling: Titanium mirror frame, acrylic lighting, LED lights
Cabin wall: Three-sided titanium mirror etching
Floor: PVC (marble optional)



CON-C77 Optional

Ceiling: Titanium mirror frame, acrylic lighting, LED lights
Cabin wall: Three-sided titanium mirror etching
Floor: PVC (marble optional)



CON-C74 Optional

Ceiling: Titanium mirror frame, acrylic lighting, LED lights
Cabin wall: Three-sided titanium mirror etching
Floor: PVC (marble optional)



CON-C75 Optional

Ceiling: Titanium mirror frame, acrylic lighting, LED lights
Cabin wall: Three-sided titanium mirror etching
Floor: PVC (marble optional)

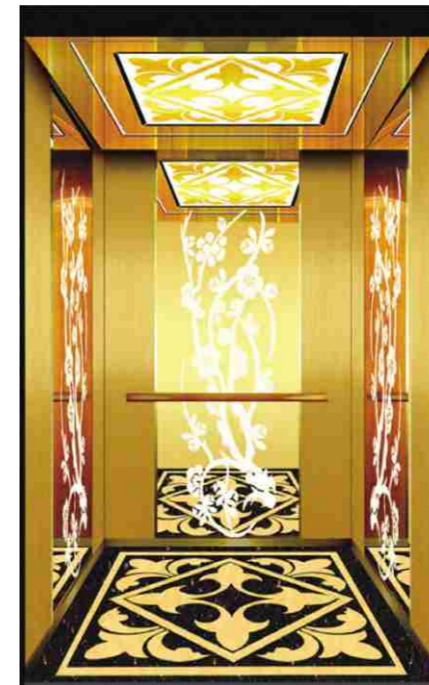

CON-C78 Optional

Ceiling: Titanium mirror frame, acrylic lighting
Cabin wall: Three-sided titanium mirror etching
Floor: PVC (marble optional)

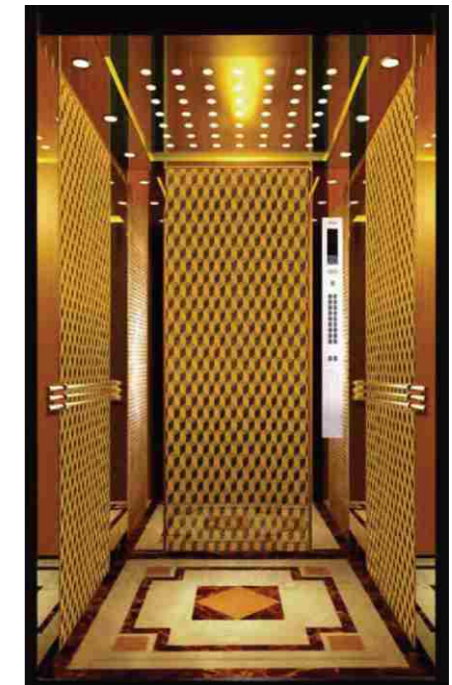

CON-C79 Optional

Ceiling: Titanium mirror frame, acrylic lighting, LED lights
Cabin wall: Three-sided titanium mirror etching
Floor: PVC (marble optional)

PREMIUM CABIN DESIGN OPTIONAL



CON-C80

Optional

Ceiling: Titanium mirror frame, acrylic lighting, LED lights
Cabin wall: Three-sided titanium mirror etching
Floor: PVC (marble optional)



CON-C81

Optional

Ceiling: Titanium mirror frame, acrylic lighting, LED lights
Cabin wall: Three-sided titanium mirror etching
Floor: PVC (marble optional)



CON-C84

Optional

Ceiling: Titanium mirror frame, acrylic lighting, LED lights
Cabin wall: Three-sided titanium mirror etching
Floor: PVC (marble optional)



CON-C85

Optional

Ceiling: Titanium mirror frame, acrylic lighting, LED lights
Cabin wall: Three-sided titanium mirror etching
Floor: PVC (marble optional)



CON-C82

Optional

Ceiling: Titanium mirror frame, acrylic lighting, LED lights
Cabin wall: Three-sided titanium mirror etching
Floor: PVC (marble optional)



CON-C83

Optional

Ceiling: Titanium mirror frame, acrylic lighting, LED lights
Cabin wall: Three-sided titanium mirror etching
Floor: PVC (marble optional)

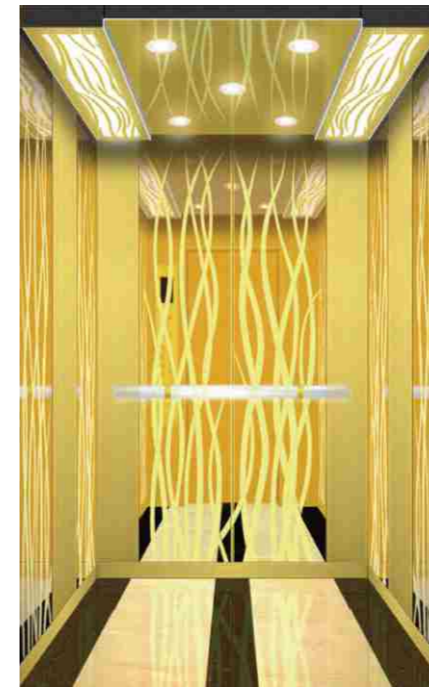

CON-C86

Optional

Ceiling: Titanium mirror frame, acrylic lighting, LED lights
Cabin wall: Three-sided titanium mirror etching
Floor: PVC (marble optional)

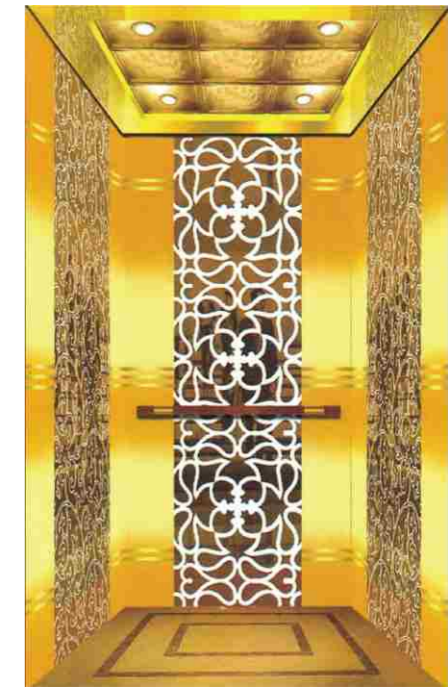

CON-C87

Optional

Ceiling: Titanium mirror frame, acrylic lighting, LED lights
Cabin wall: Three-sided titanium mirror etching
Floor: PVC (marble optional)

ULTRA PREMIUM CABIN DESIGN OPTIONAL



CON-C88

Optional

Ceiling: Mirror stainless steel frame, acrylic transparent plate, LED lights
 Cabin wall: Mirror etching of rose gold on three sides
 Floor: PVC (marble optional)



CON-C89

Optional

Ceiling: Roes gold mirror frame, acrylic lighting, LED lights
 Cabin wall: Mirror etching of rose gold on three sides
 Floor: PVC (marble optional)



CON-C92

Optional

Ceiling: Roes gold stainless steel frame, acrylic lighting, LED lights
 Cabin wall: Mirror etching of rose gold on three sides
 Floor: PVC (marble optional)



CON-C93

Optional

Car roof: Roes gold stainless steel frame, LED lights
 Cabin wall: Mirror etching of rose gold on three sides
 Floor: PVC (marble optional)



CON-C90

Optional

Ceiling: Roes gold stainless steel frame, acrylic lighting, LED lights
 Cabin wall: Mirror etching of rose gold on three sides
 Floor: PVC (marble optional)



CON-C91

Optional

Ceiling: Roes gold mirror frame, acrylic lighting, LED lights
 Cabin wall: Mirror etching of rose gold on three sides
 Floor: PVC (marble optional)



CON-C94

Optional

Ceiling: Roes gold mirror frame
 Cabin wall: Mirror etching of rose gold on three sides
 Floor: PVC (marble optional)



CON-C95

Optional

Ceiling: Roes gold mirror frame, acrylic lighting, LED lights
 Cabin wall: Mirror etching of rose gold on three sides
 Floor: PVC (marble optional)

HIGH END CABIN DESIGN OPITONAL

BLACK TITANIUM MIRROR



CON-C96

Optional

Ceiling: Black titanium mirror frame, acrylic lighting
Cabin wall: Black titanium mirror etching
Floor: PVC (marble optional)

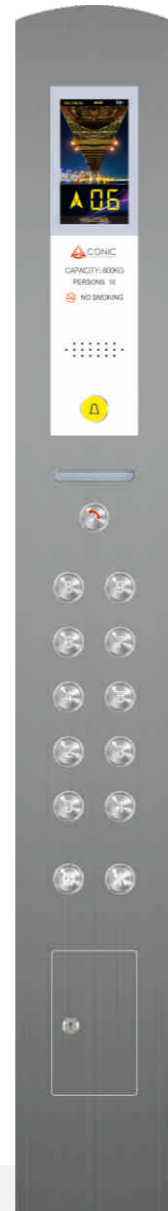

CON-COP-3

COP 304SS Mirror, LOP 304SS Mirror Glass optional
COP faceplate size: 1370*180, install size: 1330*155
COP display: Photo display
LOP display: DOT LCD display optional



Scan the QR code
watch the car



CON-LOP-3



CON-LOP-4



CON-C97

Optional

Ceiling: Black titanium mirror frame, acrylic lighting, LED lights
Cabin wall: Black titanium mirror etching
Floor: PVC (marble optional)

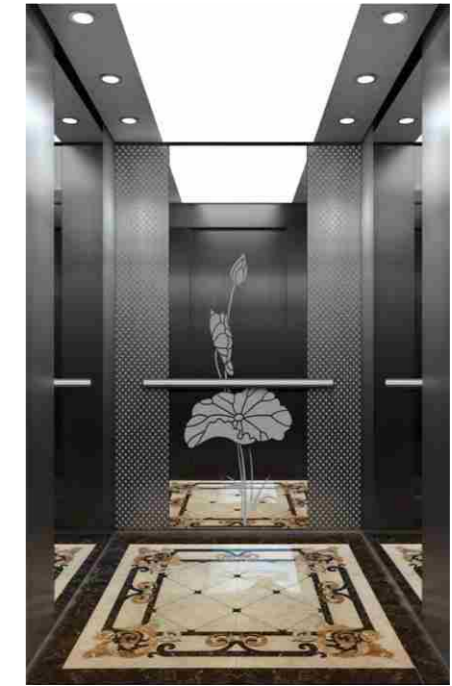

CON-C98

Optional

Ceiling: Black titanium stainless steel frame, acrylic lighting, LED lights
Cabin wall: Black titanium mirror etching
Floor: PVC (marble optional)



CON-C99

Optional

Ceiling: Black titanium mirror frame, acrylic lighting, LED lights
Cabin wall: Black titanium mirror etching
Floor: PVC (marble optional)



CON-C100

Optional

Ceiling: Starry ceiling
Cabin wall: Three-sided black titanium mirror etching
Floor: PVC (marble optional)

CUSTOMIZED CABIN DESIGN OPTIONAL



CON-C101 Optional
 Ceiling: Mirror stainless steel frame, acrylic lighting
 Cabin wall: Mirror etching on 3 sides
 Floor: PVC (marble optional)



CON-C102 Optional
 Ceiling: Mirror stainless steel frame, acrylic lighting, LED lights
 Cabin wall: Mirror etching on 3 sides
 Floor: PVC (marble optional)



CON-C105 Optional
 Ceiling: Hairline stainless steel frame, acrylic lighting, LED lights
 Cabin wall: Mirror etching on 3 sides
 Floor: PVC (marble optional)

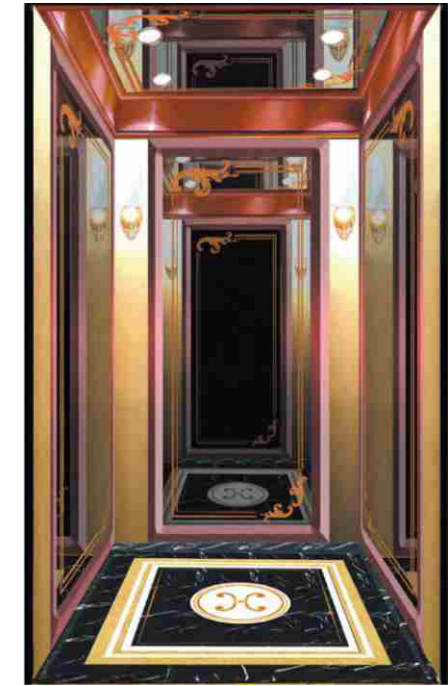

CON-C106 Optional
 Ceiling: Mirror stainless steel frame, acrylic lighting, LED lights
 Cabin wall: Mirror etching on 3 sides
 Floor: PVC (marble optional)



CON-C103 Optional
 Ceiling: Hairline stainless steel frame, acrylic lighting, LED lights
 Cabin wall: Mirror etching on 3 sides
 Floor: PVC (marble optional)



CON-C104 Optional
 Ceiling: The middle part is a soft lighting design with arched white organic light-transmitting panels
 Cabin wall: Mirror etching on 3 sides
 Floor: PVC (marble optional)



CON-C107 Optional
 Ceiling: Hairline stainless steel frame, acrylic lighting, LED lights
 Cabin wall: Mirror etching on 3 sides
 Floor: PVC (marble optional)



CON-C108 Optional
 Ceiling: Bronze stainless steel, acrylic lighting, downlight
 Cabin wall: Bronze stainless steel, mirror etched stainless steel
 Floor: PVC (marble optional)

Small machine room passenger Elevator construction parameters

Machine roomless passenger Elevator construction parameters

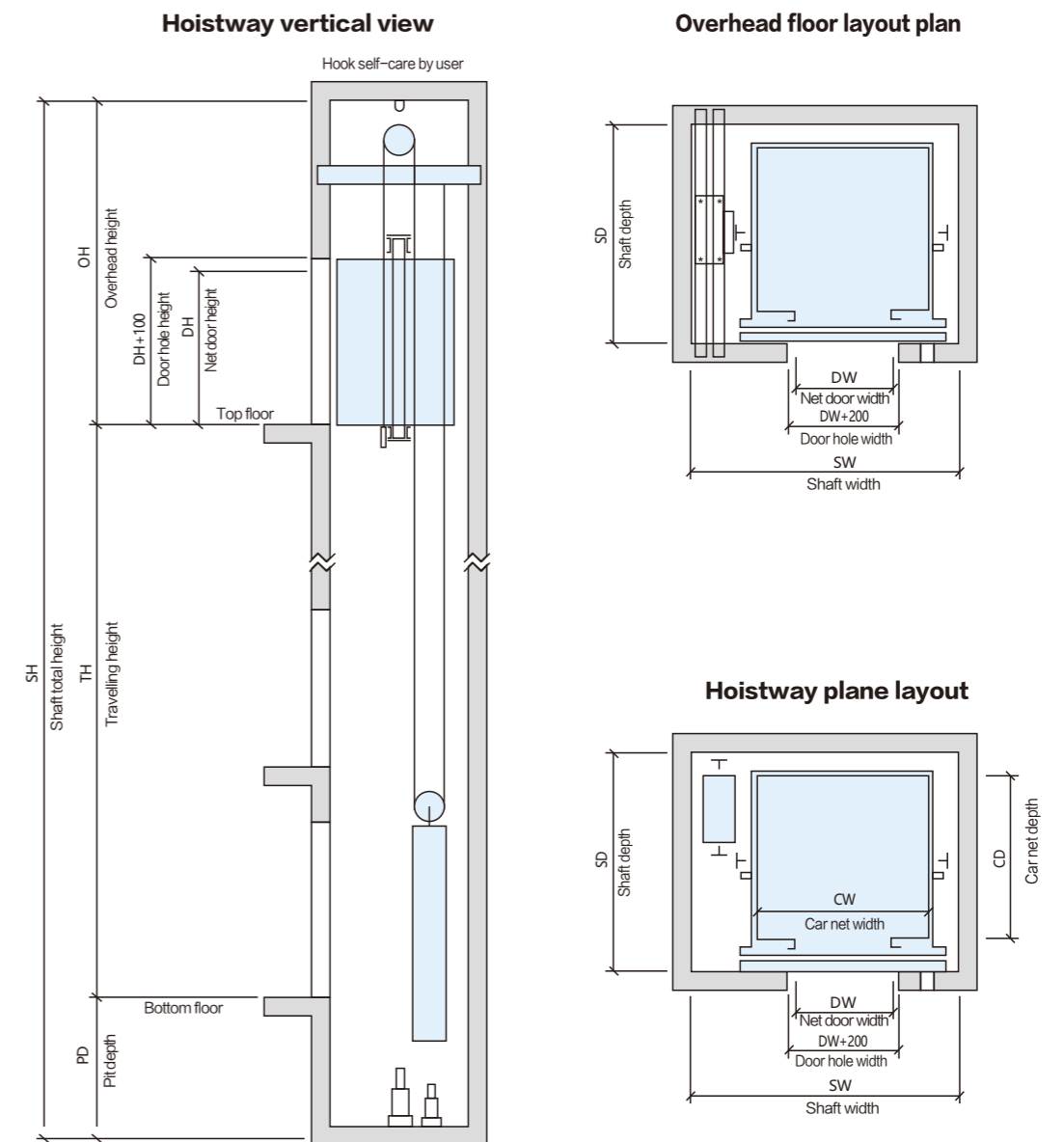
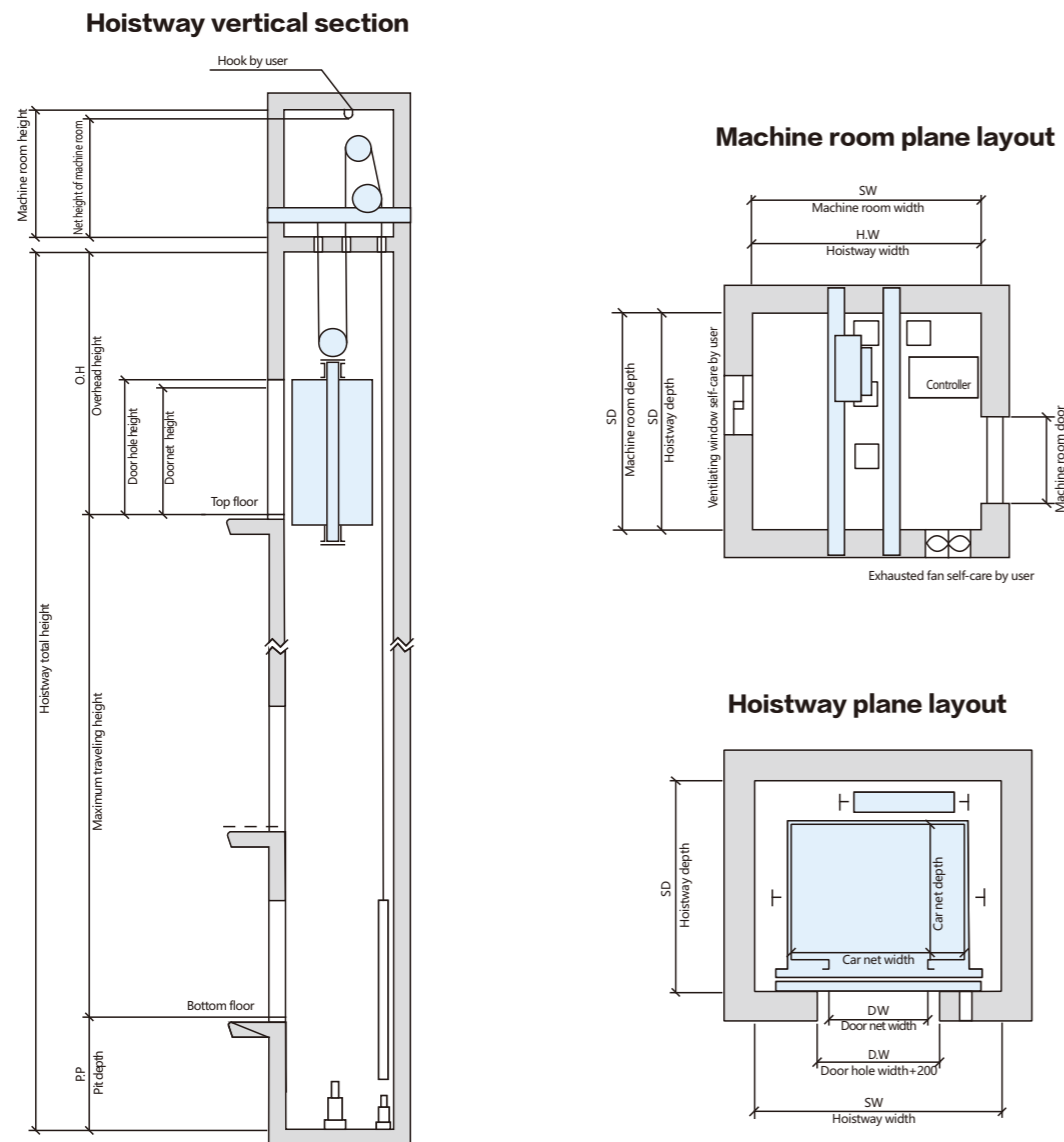

Load (kg)	Speed (m/s)	Car dimension (mm) Inner size AxB	Door-opening size (mm)		Hoistway size (mm) SWxSD	Machine room size (mm) SWxSD	Overhead height (mm)	Pit depth (mm)	Maximum lifting height (m)
			DW Door net opening	DH Net door height					
630	1.0	1400x1100	800	2100	2000x1800	2000x3500	4500	1500	105
	1.5						4700	1700	
	2.0						4900	2000	
800	1.0	1400x1350	800	2100	2000x2000	2000x3800	4500	1500	105
	1.5						4700	1700	
	2.0						4900	2000	
1000	1.0	1600x1400	900	2100	2200x2100	2200x2400	4500	1500	105
	1.5						4700	1700	
	2.0						4900	2000	
1250	1.0	1800x1550	1100	2100	2400x2300	2400x4100	4500	1500	105
	1.5						4700	1700	
	2.0						4900	2000	
1600	1.0	1950x1700	1100	2100	2600x2450	2600x4500	4500	1500	105
	1.5						4700	1700	
	2.0						4900	2000	

The data is for design reference only. For the detailed parameters, please take the technical drawing as the criterion.

Note: If the specification exceeds above range, please contact us, Ningbo CONIC Elevator Company.

Load (kg)	Speed (m/s)	Car size (mm) CWxCD Inner size (mm)	Car door width x height (mm)	Hoistway size (mm)	Overhead height (mm)	Pit depth (mm)
	1.5	2150x1800	4700	1500		
	2.0	2250x1900	5000	1700		
800	1.0	1400x1350	800x2100	2250x2100	4500	1500
	1.5			2250x2100	4700	1500
	2.0			2350x2200	5000	1700
1000	1.0	1600x1500	900x2100	2400x2100	4500	1500
	1.5			2400x2100	4700	1600
	2.0			2500x2200	5000	1700
1150	1.0	1700x1500	1000x2100	2550x2100	4500	1500
	1.5			2550x2100	4700	1600
	2.0			2650x2200	5000	1700
1350	1.0	1800x1650	1100x2100	3000x2250	4700	1500
	1.5			3000x2250	4900	1600
	2.0			3100x2350	5100	1800
1600	1.0	2000x1700	1200x2100	3200x2300	4700	1500
	1.5			3200x2300	4900	1600
	2.0			3300x2400	5100	1800

The data is for design reference only. For the detailed parameters, please take the technical drawing as the criterion.

Note: If the specification exceeds above range, please contact us, Ningbo CONIC Elevator Company.

OBSERVATION ELEVATOR

Quiet and stable, visual feast

The observation elevators are beautifully designed and perform well, making them the perfect blend of artificial intelligence. The reliable and comfortable inner quality is harmonious with the exquisite visual beauty. It is integrated with the building and the surrounding environment to create a beautiful dynamic landscape and enjoy the modern urban style. While enjoying the beauty of the building, enjoy the comfort of the flowing space, widely used in high-end shopping malls, hotels, office buildings and other high-end places.

Different model design

The stylish and generous design style is available for customers to choose from, and the blue display part is for sightseeing glass.

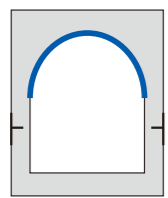

Semi-circular shaped

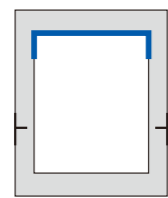

Square shaped

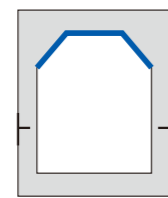

Cutting-angle-type

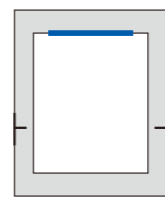

Panoramic

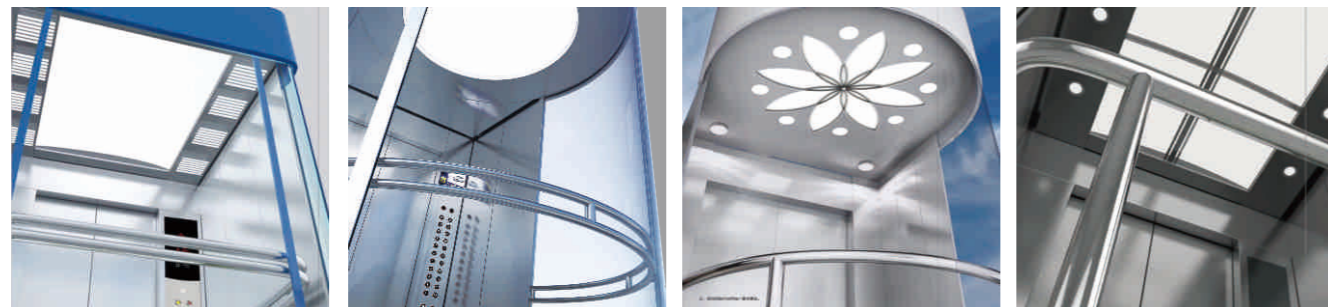

OBSERVATION ELEVATOR CABIN DECORATION



CON-G1

Paid optional



Upper and lower covers: Mirror stainless steel
 Sightseeing wall: 6+6 safety laminated glass
 Decorative top: Mirror stainless steel, acrylic top plate
 Car wall: Mirror stainless steel
 Car door: Framed glass door
 Armrest: Stainless steel single tube
 Floor: PVC (optional marble)

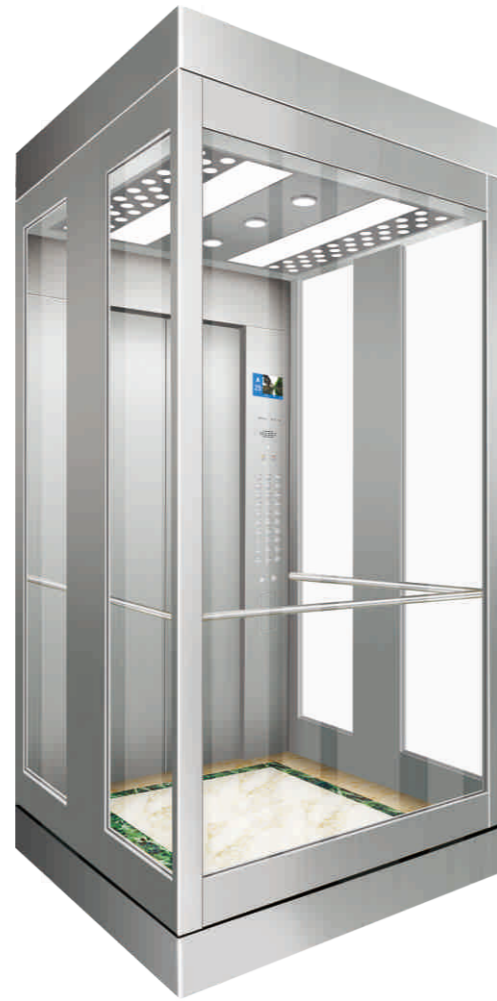

CON-G2

Paid optional



Upper and lower covers: Hairline stainless steel
 Sightseeing wall: Safety laminated glass
 Decorative top: Hairline stainless steel, milky white in the middle, acrylic lighting
 Car wall: Hairline stainless steel
 Car door: Hairline stainless steel
 Armrest: Stainless steel double tube
 Floor: PVC (optional marble)



CON-G3

Paid optional

Upper and lower cover: Mirror stainless steel rib ring
 Sightseeing wall: Safety glue glass
 Decorative top: Stainless steel hair lines, milky white in the middle, acrylic lighting
 Sedan chair wall: Hairline stainless steel
 Sedan chair door: Hairline stainless steel
 Handrails: Stainless steel double pipe
 Floor: PVC (optional marble)



CON-G4

Paid optional

Upper and lower cover: Steel plate baking paint
 Sightseeing wall: Safety glue glass
 Decorative top: Ultra-thin soft film, LED
 Sedan chair wall: Hairline stainless steel
 Armrest: Stainless steel pipe
 Floor: PVC (optional marble)



CON-G5

Paid optional

Upper and lower cover: Steel plate spray plus decorative lamp strip
 Sightseeing wall: Safety glue glass
 Decorative ceiling: Vaulted ceiling, LED lamp
 Car wall: Hairline stainless steel
 Armrest: Stainless steel pipe
 Floor: PVC (optional marble)



CON-G6

Paid optional

Upper and lower cover: Mirror stainless steel rib ring.
 Bright red acrylic decorative cover
 Sightseeing wall: Three pieces of safety glue glass
 Decorative top: Steel plate painted roof frame, milky white in the middle. Acrylic lighting
 Sedan chair wall: Hairline stainless steel
 Sedan chair door: Hairline stainless steel
 Armrest: Stainless steel double pipe
 Floor: PVC (optional marble)

VILLA ELEVATOR

It highlights the beautiful lines of craftsmanship, cooperates with advanced material selection, interprets the concept of high-end industrial design, and makes it one of the beautiful works of art in your private space.

Safe and convenient, care is often accompanied

It is specially developed and developed for mid-to-high-end villas and split-level residences, with exquisite layout, diverse styles, and outstanding performance. It is suitable for villas and split-level residences without elevators to meet your high-quality life needs.

Humanized open door style

It adopts a variety of door opening methods to provide users with choices, and can be specially designed according to needs and usage conditions.

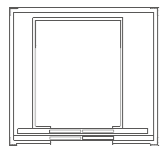

Center-opening

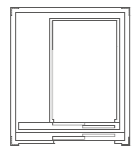

Side-opening

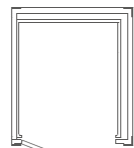

Manually operated door

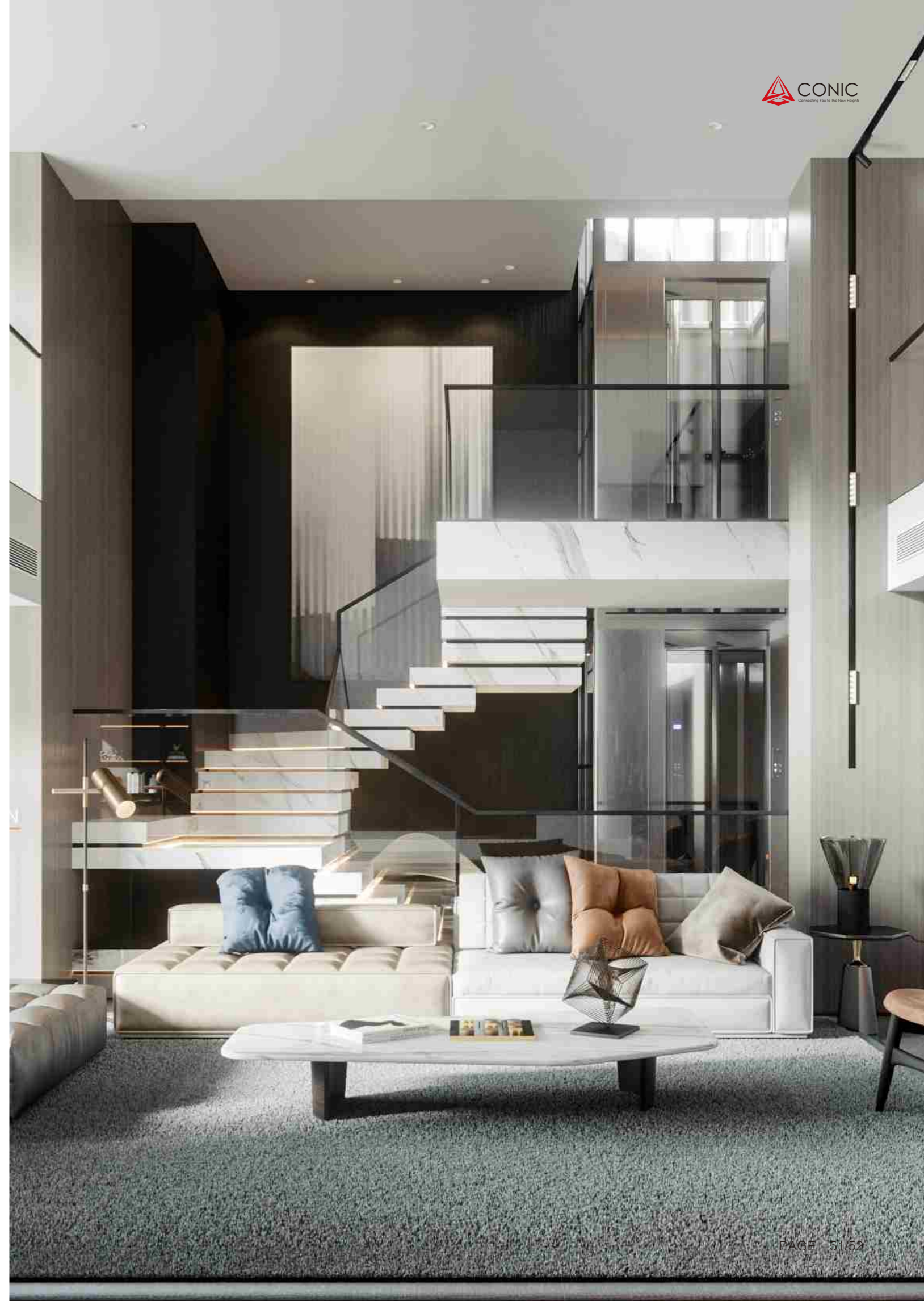

VILLA ELEVATOR CABIN DECORATION



CON-V1 Optional

Ceiling: Bronze sandblasted stainless steel frame, hidden light belt, LED
 Car wall: Bronze mirror stainless steel trim, bronze sandblasted stainless steel, LED, wood veneer
 Car door: Bronze mirror stainless steel
 Handrail: Bronze hairline stainless steel, hidden light belt
 Floor: PVC (optional marble)



Scan the QR code
watch the car



CON-LOP-V1



CON-COP-V1



CON-V2 Optional

Ceiling: Hairline stainless steel, acrylic transparent board, LED
 Car wall: Hairline stainless steel
 Car door: Hairline stainless steel
 Floor: PVC (optional marble)



CON-V3 Optional

Ceiling: Champagne gold mirror stainless steel frame, LED
 Car wall: Champagne gold mirror stainless steel, champagne gold sandblasted
 Car door: Champagne gold pattern stainless steel
 Handrail: Champagne gold sandblasted
 Floor: PVC (optional marble)



CON-V4 Optional

Ceiling: Steel plate spraying, black titanium mirror stainless steel trim, hidden light belt
 Car wall: Black titanium hairline stainless steel, wire glass, mirror stainless steel trim, wood veneer
 Car door: Black titanium hairline stainless steel
 Handrail: Wood veneer stainless steel
 Floor: PVC (optional marble)



CON-V5 Optional

Ceiling: Black titanium mirror stainless steel, acrylic
 Car wall: Black titanium mirror stainless steel, colored steel plate
 Floor: PVC (optional marble)



ELEVATOR COP & HOP

COP

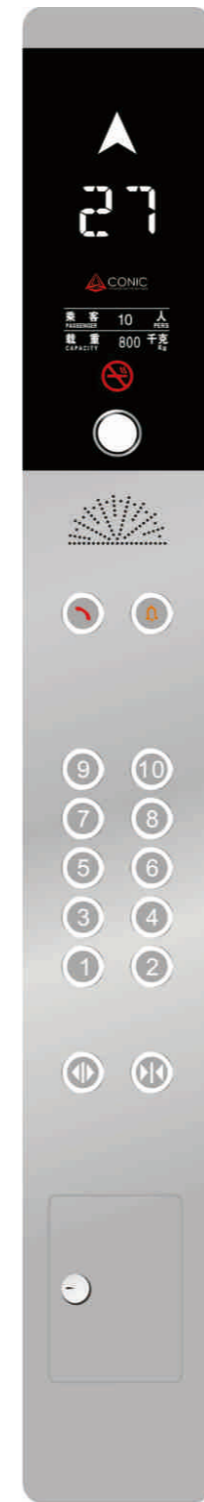
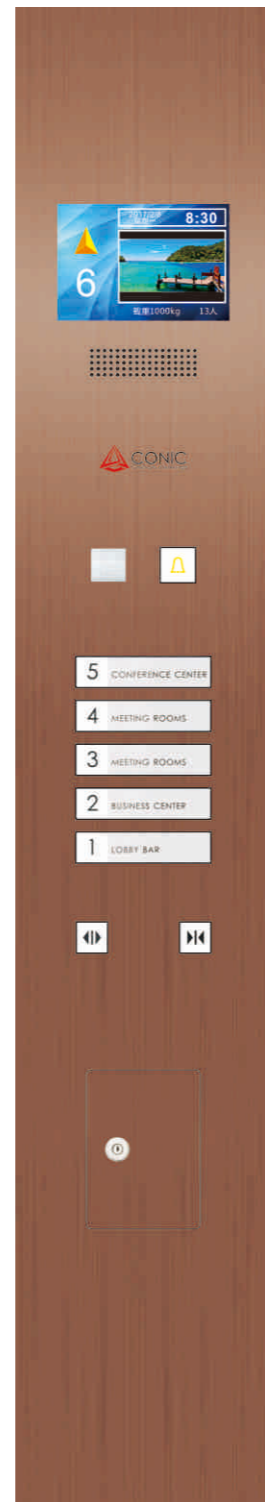
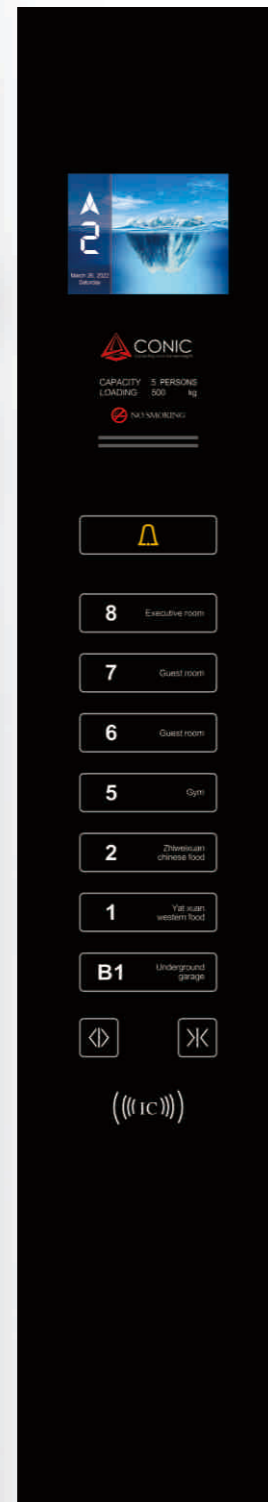

Display optional

10.4 / 8 / 7 Inch TFT Photo Display With Voice, can customized theme picture;



GNL-TFT7-PH-N3K



GNL-TFT8-PH-N3K



GNL-TFT104-PH-N3K

6.4 / 4.3 Inch Blue/Black background LCD Display

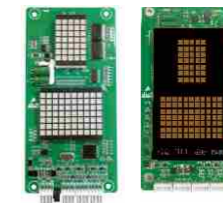

4.3 Inch dot display



4.3 Inch Fixed color LCD



4.3 Inch HD Display



Button optional



ELEVATOR COP & HOP

COP

HOP

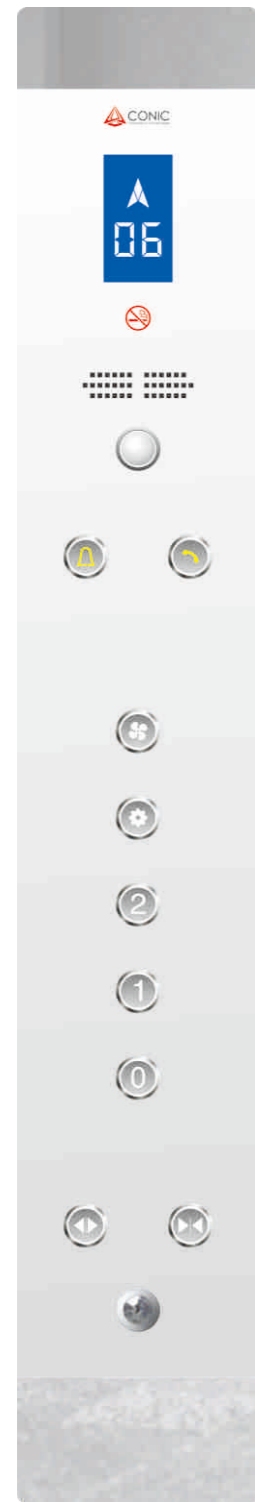

CON-COP-W1



CON-COP-W2

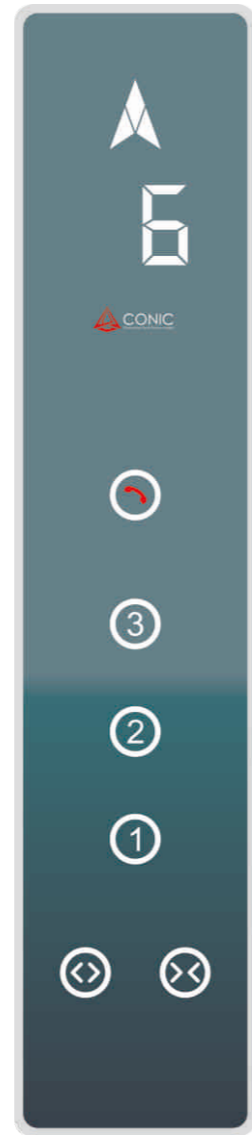

CON-COP-W3

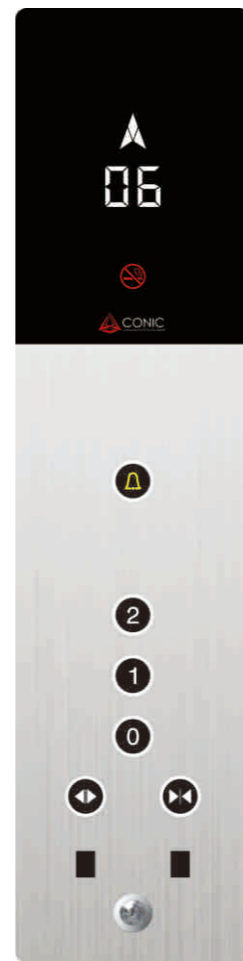

CON-COP-W4



CON-LOP-W1



CON-LOP-W2



CON-LOP-W3



CON-LOP-W4



CON-LOP-W5



CON-LOP-W6



CON-LOP-W7



CON-LOP-W8



CON-LOP-W9



CON-LOP-W10



CON-LOP-W11



CON-LOP-W12



CON-LOP-W13



CON-LOP-W14



CON-LOP-W15



CON-LOP-W16

CEILING SERIES



CON-E01

Mirror stainless steel frame, acrylic transparent board, LED



CON-E02

Mirror stainless steel frame, acrylic transparent board, LED

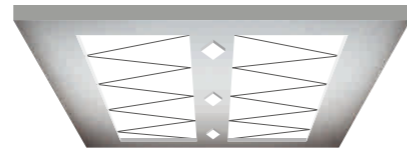

CON-E03

Mirror stainless steel frame, acrylic transparent board, LED



CON-E04

Mirror stainless steel frame, acrylic transparent board, LED



CON-E05

Mirror stainless steel frame, acrylic vault, LED



CON-E06

Mirror stainless steel frame, acrylic vault, LED



CON-E07

Mirror stainless steel frame, acrylic transparent board, LED



CON-E08

Black titanium mirror stainless steel frame, acrylic transparent plate, LED

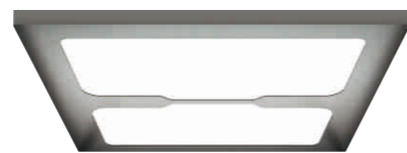

CON-E09

Diamond silver painted steel with acrylic photic board.



CON-E10

Diamond silver painted steel with acrylic board

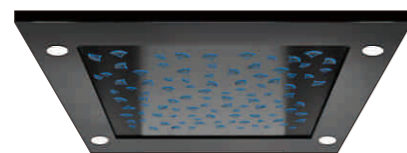

CON-E11

Black titanium mirror stainless steel frame, down lamp, top panel LED lighting

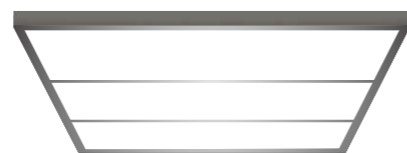

CON-E12

Diamond silver painted steel with acrylic photic board.

FLOOR SERIES

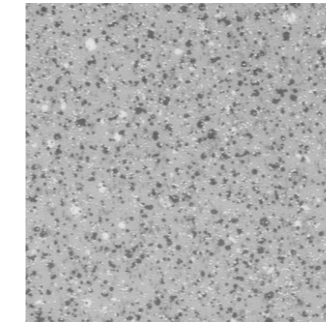

CON-F01



CON-F02



CON-F03



CON-F04

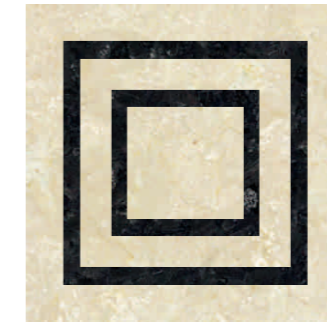

CON-F05



CON-F06

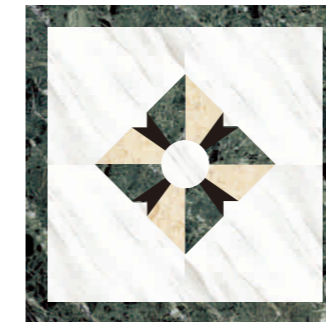

CON-F07



CON-F08



CON-F09



CON-F010



CON-F011



CON-F012

HANDRAIL SERIES



CON-FS01
Mirror stainless steel single tube



CON-FS02
Mirror stainless steel double tube



CON-FS03
Mirror stainless steel flat handrail



CON-FS04
Titanium mirror stainless steel flat armrest



CON-FS05
Turquoise acrylic flat armrest



CON-FS06
Titanium mirror stainless steel, turquoise acrylic combination single tube

DOOR HORIZONTAL DISPLAY



4.3 inch blue background white LCD horizontal display



6.4-inch blue background and white door horizontal display



6.4 inch black and white LCD horizontal display



6.4 inch blue background white LCD horizontal display

ARRIVAL LIGHT



HALL DOOR SERIES



CON-D01
Mirror stainless steel, etching



CON-D02
Mirror stainless steel, etching



CON-D03
Mirror stainless steel, etching



CON-D04
Mirror stainless steel, etching



CON-D05
Mirror stainless steel, etching



CON-D06
Mirror stainless steel, etching



CON-D07
Titanium mirror stainless steel, etching



CON-D08
Titanium mirror stainless steel, etching



CON-D09
Titanium mirror stainless steel, etching



CON-D10
Rose gold mirror stainless steel, etching



CON-D11
Rose gold mirror stainless steel, etching



CON-D12
Mirror stainless steel, Observation glass

PASSENGER ELEVATOR FUNCTION

S- Standard O- Optional

Run function	
S Elevator frequency conversion drive	Accurately adjust the motor speed to make the speed curve of the elevator start, run and stop smooth and smooth, and get a good sense of comfort.
S Door machine variable frequency drive	Accurately adjust the motor speed to make the opening and closing of the door operator more gentle and sensitive.
S Operate independently	Through the action switch, the elevator does not respond to hall calls, but only responds to commands in the car.
S Automatic adjustment of door opening time	According to the difference between the landing call or the car call, the time for holding the door is automatically adjusted.
S Reopen the door on this floor	On the way to closing the door, you can press the call button of this floor to reopen the door.
S Close immediately	When the elevator stops and opens the door in place, press the door close button and the door will be closed immediately.
S Stop the elevator and open the door	The elevator decelerates to level the floor and does not open the door until it has completely stopped.
S Car arrival bell	The chime of the electronic clock mounted on the top of the car informs the waiting passengers that the elevator has arrived.
S Order registration deletion	If you press the wrong floor command button in the car, you can cancel the registered command by pressing the same button twice.
S Dock directly	According to the principle of distance, there is no creeping on the leveling layer, which greatly improves the operation efficiency.
S Open the door early	The elevator decelerates and enters the door opening area and automatically opens the door to improve operation efficiency.
O Automatic non-stop passing	When the car is full of passengers or the load is close to a predetermined value, in order to maintain operating efficiency, the car will automatically pass the calling landing.
O Anti-trouble	When there are more than three commands when the elevator is lightly loaded, in order to avoid unnecessary stops, all the registered calls in the car will be automatically eliminated.
O Group control function	It is used for group control of three or more elevators of the same model, so that the elevator group can choose the appropriate response by itself, and avoid repeated stop of the elevator. Shorten passenger waiting time and improve operation efficiency.
O Parallel function	It is used for two elevators of the same model, and the dispatching of the computer is used to uniformly respond to the call information, reduce the waiting time of the passengers, and improve the operation efficiency.
O Peak service	During the scheduled working hours, when the upward transportation of the base station is particularly busy, elevators are continuously dispatched to the base station to meet the peak demand during work.
O Rush hour service	During the scheduled off-duty hours, assign elevators to the top floor to meet the peak demand during off-duty.
O Extended opening time	Press the dedicated button in the car to keep the door open for a period of time.

HMI	
S In-car and landing micro-motion command buttons	The command button of the control box in the car and the landing call button adopt a new type of micro-motion button.
S Number of floors and direction indication in the car	In the car, the floor number and current running direction of the elevator are displayed.
S Floor number and direction indication	The landing displays the number of floors and the current running direction of the elevator.
S Voice announcement	In the case of normal operation arriving at the station, the voice device is used to inform passengers of relevant information.
S Voice soothing function	When the elevator fails, the elevator emits a voice soothing tone and informs the maintenance personnel to arrive at the scene in time for treatment.
O Car auxiliary control box	It is used in large-load elevators or elevators in buildings with dense waiting crowds, so that more passengers in the car can use it conveniently.
O Handicapped control box	It is convenient for passengers in wheelchairs and visually impaired passengers in the car.
O Smart call service	Through a dedicated intelligent input device, the car command or out-of-hall call can be locked or connected.
O IC card control function	All (part of) landings must be authorized before they can operate the elevator by inputting car instructions through the IC card.

Monitoring function

S Remote monitoring	Through the Internet of Things, remote monitoring of elevators can be realized, which is convenient for manufacturers and service units to understand the operating status of each elevator in time, so that corresponding maintenance measures can be taken in time
O Remote control	By operating the monitoring screen (optional), the elevator can be operated independently according to the specified needs.
O Camera function in the car	The camera is installed in the car to monitor the situation in the car.

Security function

S Light curtain protection	During the opening and closing of the door, an infrared light curtain covering the entire height of the door is used to detect passengers and objects as a door protection device.
S Designated dock	For some reason, the elevator cannot open the door at the destination floor, and the elevator will close the door and run to the next designated floor.
S Overload stop elevator	When the car is overloaded, the buzzer will sound and stop at the landing.
S Internal counter protection to prevent stall	When the traction wire rope slips and cannot run normally, the elevator stops running.
S Start protection control	After the elevator starts, the elevator stops running if it does not leave the door area within the specified time.
S Maintenance operation	When entering the inspection state, the car jogs at low speed.
S Fault self-diagnosis	The controller can record the latest 62 failures, so as to quickly eliminate the failures and quickly restore the elevator operation.
S Repeated opening and closing of elevator doors	Sometimes the elevator door fails to close due to obstruction or interference, and the elevator door will repeatedly open or close until the debris is removed.
S Up and down over-layer and upper and lower limit protection device	The device can effectively prevent the top or bottom collision in case the elevator is out of control, making the elevator safer and more reliable.
S Downstream overspeed protection device	When the descending speed of the elevator exceeds 1.2 times the rated speed, the device automatically cuts off the control power supply and stops the motor to prevent the elevator from overspeeding down, if the elevator continues to go down at an overspeed, and its speed exceeds 1.4 times the rated speed, the safety gear will act to force the elevator to stop running to ensure safety.
S Uplink overspeed protection device	When the upward speed of the elevator exceeds 1.2 times the rated speed, the device will automatically decelerate or brake the elevator to a stop.
S Unintentional movement of the car	When the elevator car is in the state of opening the door, the car will stop moving when the car moves unexpectedly.

Emergency function

S Emergency lighting	When the power fails, the emergency lighting in the car is automatically turned on.
S Electric operation	When entering the emergency electric state, the car runs electrically at a low speed.
S Five-way communication device	Through the walkie-talkie, it is possible to talk among the car, the car top, the elevator machine room, the pit of the shaft, and the rescue duty room.
S Alarm bell	In an emergency, continuously press the alarm button on the control box in the car, and the electric bell installed on the top of the car will ring.
S Fire return	Turn on the key switch on the base station or monitoring screen, all calls are cancelled, the elevator immediately drove to the designated rescue landing station to stop, and automatically opened the door.
O Power failure emergency leveling	When the normal power supply is cut off, the rechargeable battery provides power to the elevator, and the elevator moves to the nearest landing.

Energy saving function

S Car fan/lighting automatic switch	If there is no call or command signal within the specified time, the fan and lighting in the car will be automatically turned off to save energy.
S Remote shutdown	Through the key switch, the elevator can be called to the base station (after the service is completed) and automatically exit the service.

HOSPITAL ELEVATOR

Fully consider the special needs of medical institutions, optimize the car structure to facilitate the transportation of hospital beds, medical staff and other medical equipment; carefully consider every detail such as the control box and handrails to create a healthy and safe travel space.

Car air sterilization and purification solution

The special negative ion generator and ultraviolet sterilization lamp and other five layer filter for the elevator can achieve the fast circulation and purification of the air in the car and effectively eliminate the dust and bacterium in the air.

Large depth, super heavy load, optimized car structure, can easily accommodate stretchers and beds to meet the special needs of hospitals. Green, environmentally friendly, safe and energy-saving, giving users meticulous care.

Tailor-made, safe and reliable

The high-load operation capacity meets the requirements of high-frequency, strong-carrying places with elevators, and is equipped with a large depth car to meet the requirements of daily transportation of hospital beds.

Multiple door opening methods

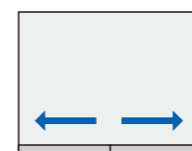

Center opening type

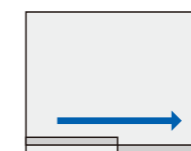

Side opening type



CON-H2201

Standard

Ceiling : Hairline stainless steel, acrylic, LED light

Car wall : Hairline stainless steel

Car door : Hairline stainless steel

Handrail: Stainless steel flat armrest

Floor : PVC



CAR ELEVATOR

Stable and comfortable quality bearing

Car elevator adopts internationally advanced elevator technology, guaranteeing sufficiently large size and load carrying of automobile product, which can satisfy the demands of park at different floors, and can be applied widely in large scaled parks, 4S stores and so on.

Car elevator adopts internationally advanced elevator technology, guaranteeing sufficiently large size and load carrying of automobile product, which can satisfy the demands of park at different floors, and can be applied widely in large scaled parks, 4S stores and so on.

The car has a large area and the rated load is generally more than 3 tons, making it easy to load a variety of small cars.

Convenient opening design

Front and rear through door settings for easy access to the car.



FLOOR



CON-FL01
 Standard
 Ordinary pattern
 steel plate

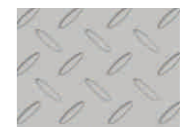

CON-FL02
 Paid optional
 Stainless steel plate
 with patterns

CON-CA2201

Optional

Ceiling: Sprayed steel plate
 Cabin wall / door: Sprayed steel plate
 Illuminate: Embedded energy-saving fluorescent lamp
 Door opening mode: Side opening type
 Floor: Checked steel plate

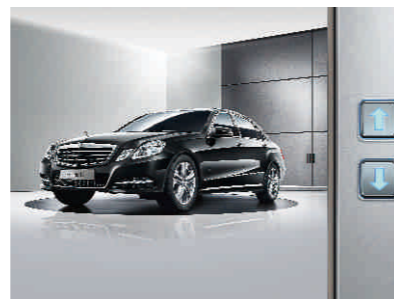

FLOOR



CON-FL01
 Standard
 Ordinary pattern
 steel plate

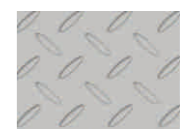

CON-FL02
 Paid optional
 Stainless steel plate
 with patterns

CON-CA2202

Optional

Ceiling: Hairline stainless steel
 Cabin wall / door: Hairline stainless steel
 Illumination: Fluorescent lamp
 Door opening mode: Center-opening & double folded type
 Floor: Checked steel plate

FREIGHT ELEVATOR

According to many years of design and use experience, and absorbing advanced manufacturing technology at home and abroad, its application of full computer modular elevator special control system, efficient and reliable driving mode, soft and sensitive VVVF frequency conversion door crane makes it easy to carry and adapt freely under various working conditions.

The setting of high-strength car structure, anti-collision bar and light screen door can meet all kinds of loading purposes and use different building structures, making more load-carrying weight lighter and more competent. To create a new concept of carrying goods.

Large opening distance sturdy and durable

The high-strength plate bending forming technology ensures that the car is solid and durable, and the company's specially designed anti-collision guardrail can be selected to give the car multiple protection.

To open the door in a multi-fold way, it has a larger door width and more efficient entry and exit of goods. at the same time, we provide a car choice that runs through the door to meet more personalized needs.



STAIR ELEVATOR

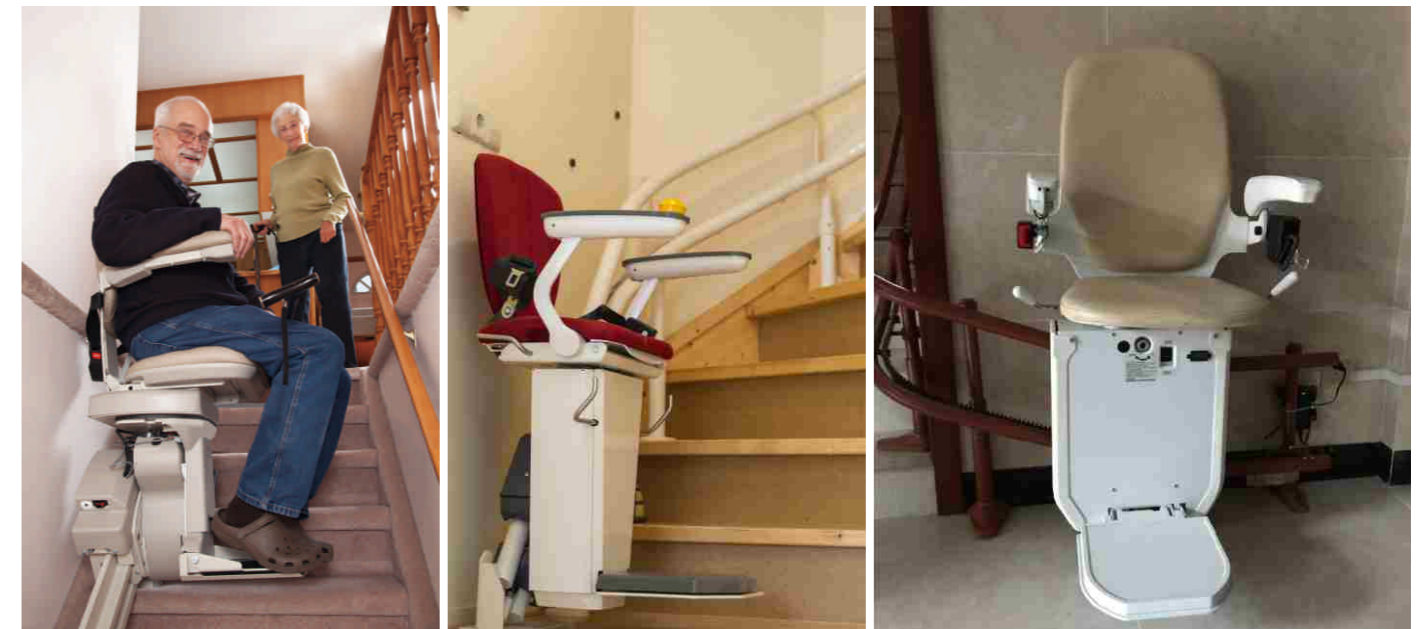

Stair elevator is a kind of non-heavy elevator, using drum type forced drive permanent magnet back step special host, no bottom pit requirements, usually comes with well frame, no weight, no gear box, small size, easy installation, can completely achieve no room, compared with the traditional hydraulic ladder, cost saving, more space saving.

Comfortable and convenient ride experience

Enjoy a convenient, smooth and comfortable experience every time you ride.

Precision track technology

The up and down stairs are smooth and stable, and the three-dimensional curve is formed at one time, so as to avoid the influence of the rail drop on the comfortable experience.

Adjustable armrest width

The adjustable range of armrest width is 40.6–50.8cm, providing users with a comfortable riding experience.

Simultaneous folding design

The seat and the footboard can be folded synchronously, without affecting the use space of the stairs.

Safe Boot

For safety reasons, if the seat armrests and equipment have not been returned, the stair lift will not start.

ESCALATOR

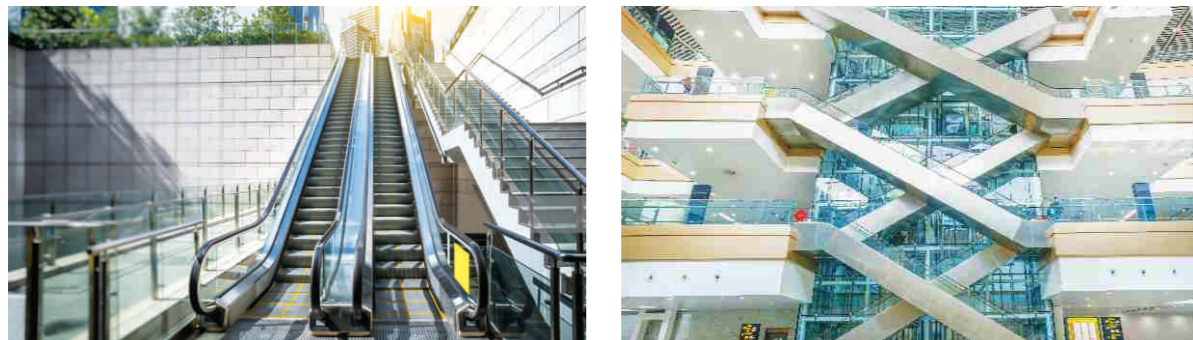

Vertically and horizontally, the escalator is sturdy and durable, safe and reliable, quiet in operation, low-carbon and environmentally friendly, and strong in carrying capacity. It provides a comfortable and fast transportation plan for urban mass traffic.

Escalator products are designed and manufactured in accordance with current international standards and Chinese standards, fully using new materials and advanced technologies at home and abroad. Smooth operation, low noise, durable and convenient maintenance. With exquisite structure, sophisticated stairway, exquisite guide, exquisite appearance, soft modern design style, combined with modern aesthetic concepts, diversified handrails and wall panels color options, dynamic streamline shape gives the city agility. The rhythm of the city adds beautiful scenery to urban public buildings such as shopping malls, supermarkets, and public buildings every day.

Escalator series products keep abreast of the pulse of the times, always adhere to "safety, energy saving, and design", and take details as the soul of the product. Each process requires 100% perfection and original universal technology for global sharing.

Focuses on the core needs of passengers, and the development of unpretentious and stable technology, just for your comfortable travel.



Comfort and stability



Safety guarantee



Low noise and environmental protection

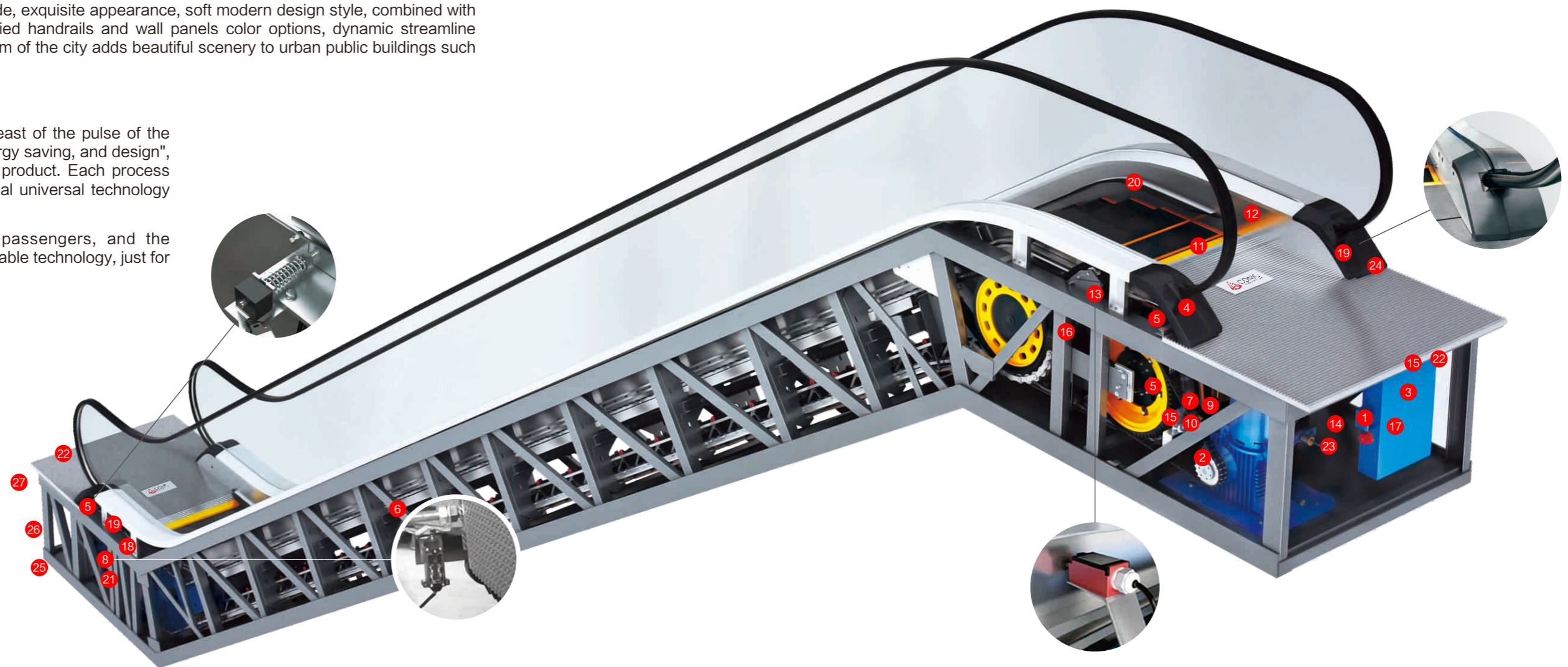

Standard safety device			
1	Out of phase and out of phase protection	15	Overhaul safety switch
2	Motor overload protection	16	Cascade gap lighting
3	Electrical circuit protection	17	Activate the alarm device
4	Handrail with entrance protection	18	Armrest belt break protection device
5	Safety protection device for comb plate	19	Handrail speed monitoring
6	Cascade collapse protection device	20	Apron brush
7	Drive chain break protection	21	Cascade loss security protection
8	Cascade chain fracture protection	22	Pedal opening safety protection
9	Overspeed protection	23	Braking distance monitoring and protection
10	Non-operational reverse protection	24	Electric additional brake (must be equipped when H > 6m)
11	Warning line	25	Lower computer room drainage (outdoor ladder)
12	Emergency stop button	26	Detection of water level in the lower computer room (outdoor ladder)
13	Apron plate protection	27	Oil-water separator (outdoor ladder)
14	Brake protection		

30° Escalator Construction Layout Drawing

35° Escalator Construction Layout Drawing

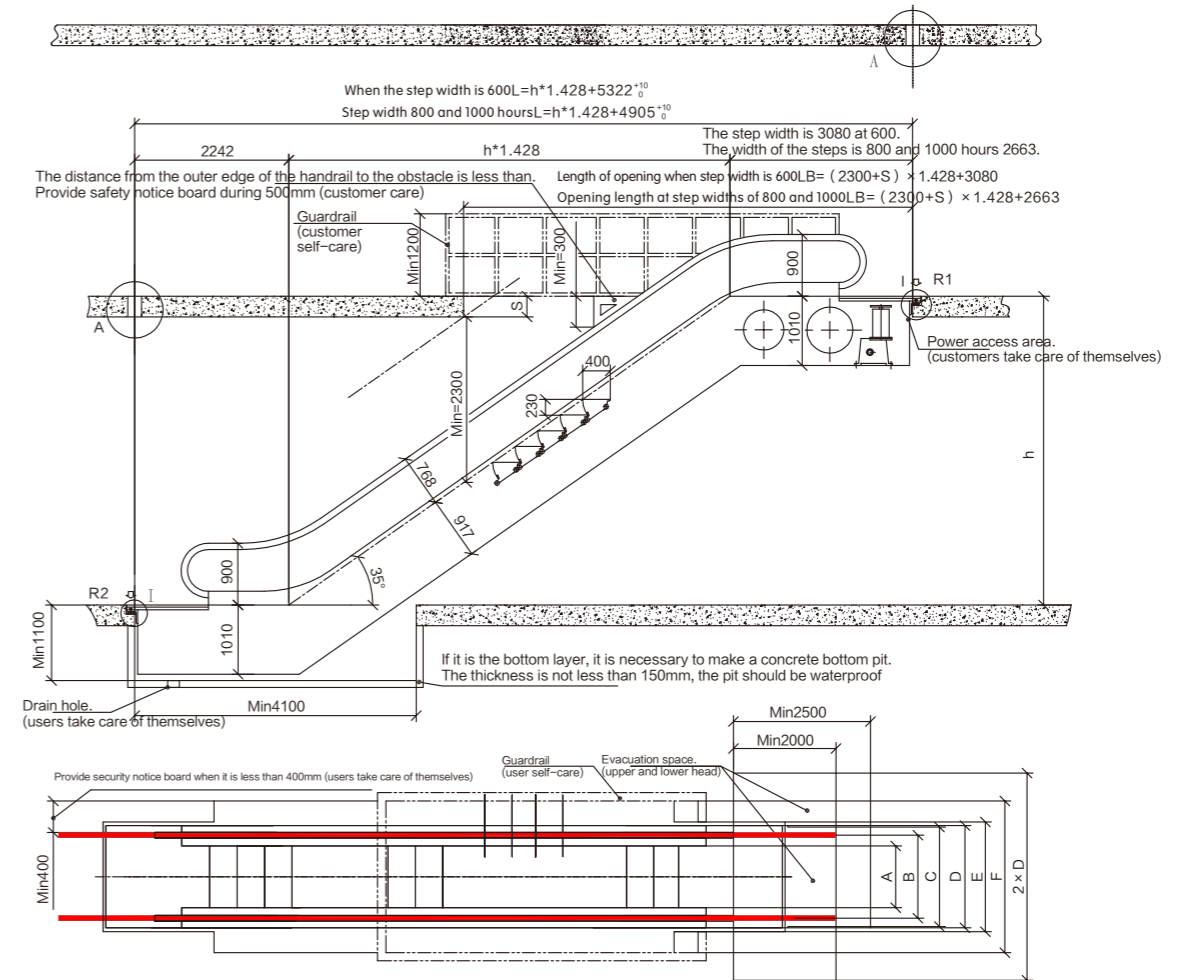
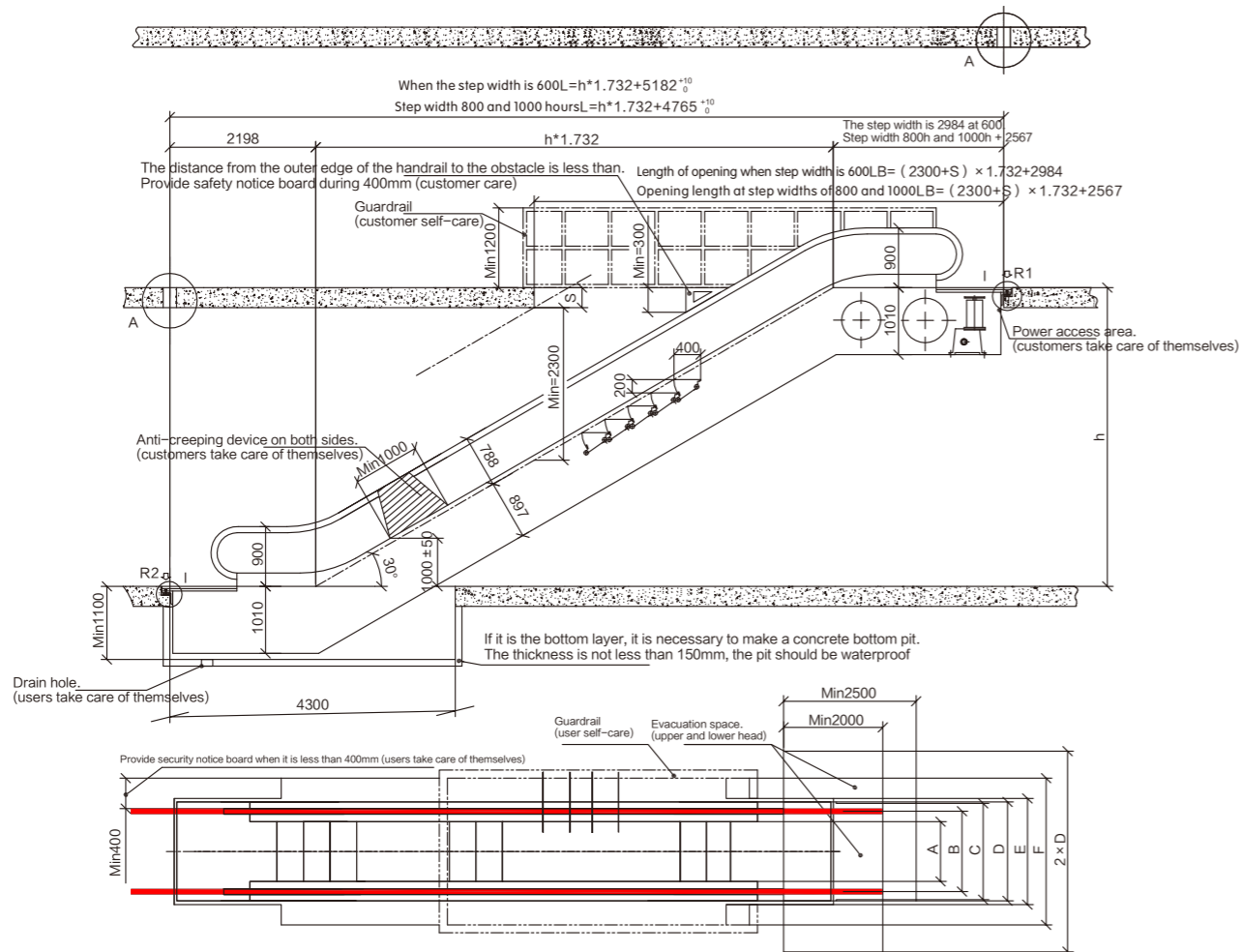

Step width A (mm)	Handrail spacing B	Truss width C	Escalator width D	Width of installation civil opening E	Safe civil engineering opening width F
1000	1238	1560	1600	1660	2317
800	1037	1360	1400	1460	2137
600	837	1160	1200	1260	1937

Model	Elevate height mm	Weight KN	Support load R1 KN	Support load R2 KN	Power	Transport size		
						H	L	
SXF930 -600 (3600p/h) SPEED0.5m/s	3000	57	46	41	5.5	2850	10180	
	3500	60	49	44		2890	11030	
	4000	64	52	47		2920	11890	
	4500	68	56	50		2940	12750	
	5000	71	59	53		2970	13610	
SXF930 -800 (4800p/h) SPEED0.5m/s	5500	75	62	56	5.5	2980	14470	
	6000	79	65	59		8	3000	15330
	3000	59	52	47		5.5	2850	10180
	3500	63	56	50			2890	11030
	4000	67	60	54			2920	11890
4500	71	64	57	2940	12750			
5000	74	68	60	2970	13610			
SXF930 -1000 (6000p/h) SPEED0.5m/s	5500	82	74	66	8	2980	14470	
	6000	86	78	69		8	3000	15330
	3000	63	59	53		5.5	2850	10180
	3500	67	64	57			2890	11030
	4000	71	68	61			2920	11890
4500	75	73	65	2940	12750			
5000	83	79	71	2970	13610			
SXF930 -1000 (6000p/h) SPEED0.5m/s	5500	87	84	75	11	2980	14470	
	6000	92	88	79		3000	15330	

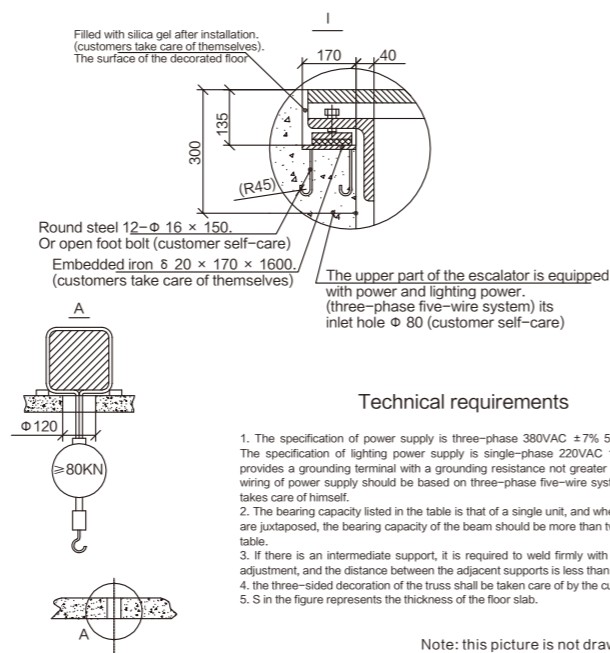

Step width A (mm)	Handrail spacing B	Truss width C	Escalator width D	Width of installation civil opening E	Safe civil engineering opening width F
1000	1238	1560	1600	1660	2317
800	1037	1360	1400	1460	2137
600	837	1160	1200	1260	1937

Model	Elevate height mm	Weight KN	Support load R1 KN	Support load R2 KN	Power	Transport size		
						H	L	
SXF930 -600 (3600p/h) SPEED0.5m/s	3000	54	43	39	5.5	2850	10180	
	3500	57	46	41		2890	11030	
	4000	60	49	44		2920	11890	
	4500	64	52	46		2940	12750	
	5000	67	54	49		2970	13610	
SXF930 -800 (4800p/h) SPEED0.5m/s	5500	70	57	51	5.5	2980	14470	
	6000	73	60	54		8	3000	15330
	3000	56	69	44		5.5	2850	10180
	3500	60	52	47			2890	11030
	4000	63	56	50			2920	11890
4500	66	59	53	2940	12750			
5000	70	62	56	2970	13610			
SXF930 -1000 (6000p/h) SPEED0.5m/s	5500	73	65	59	8	2980	14470	
	6000	76	69	61		8	3000	15330
	3000	60	56	50		5.5	2850	10180
	3500	64	60	53			2890	11030
	4000	67	64	57			2920	11890
4500	71	67	60	2940	12750			
5000	74	71	64	2970	13610			
SXF930 -1000 (6000p/h) SPEED0.5m/s	5500	82	77	69	11	2980	14470	
	6000	85	81	72		3000	15330	

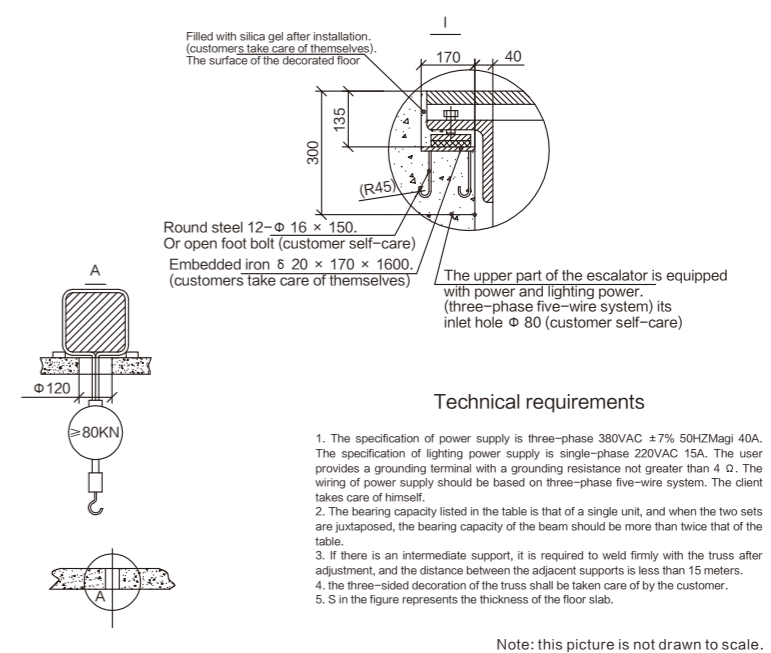

MOVING WALK

Moving walk is based on advanced industrial technology and fashion taste, and has the characteristics of low noise, stable operation, durability, high efficiency and safety. Satisfy the needs of customers to the greatest extent, allowing you to travel, shop, and enjoy the most leisurely and comfortable moments.

Moving walk series adopts a novel, fashionable and creative design, waiting quietly in every corner of the city with an elegant and atmospheric posture.

The powerful carrying capacity all demonstrates its advanced technology, reliable carrying and comfortable riding. The industry's advanced innovative technologies realize safe, energy-saving, and environmentally-friendly green operations, and promote the sustainable development of cities.

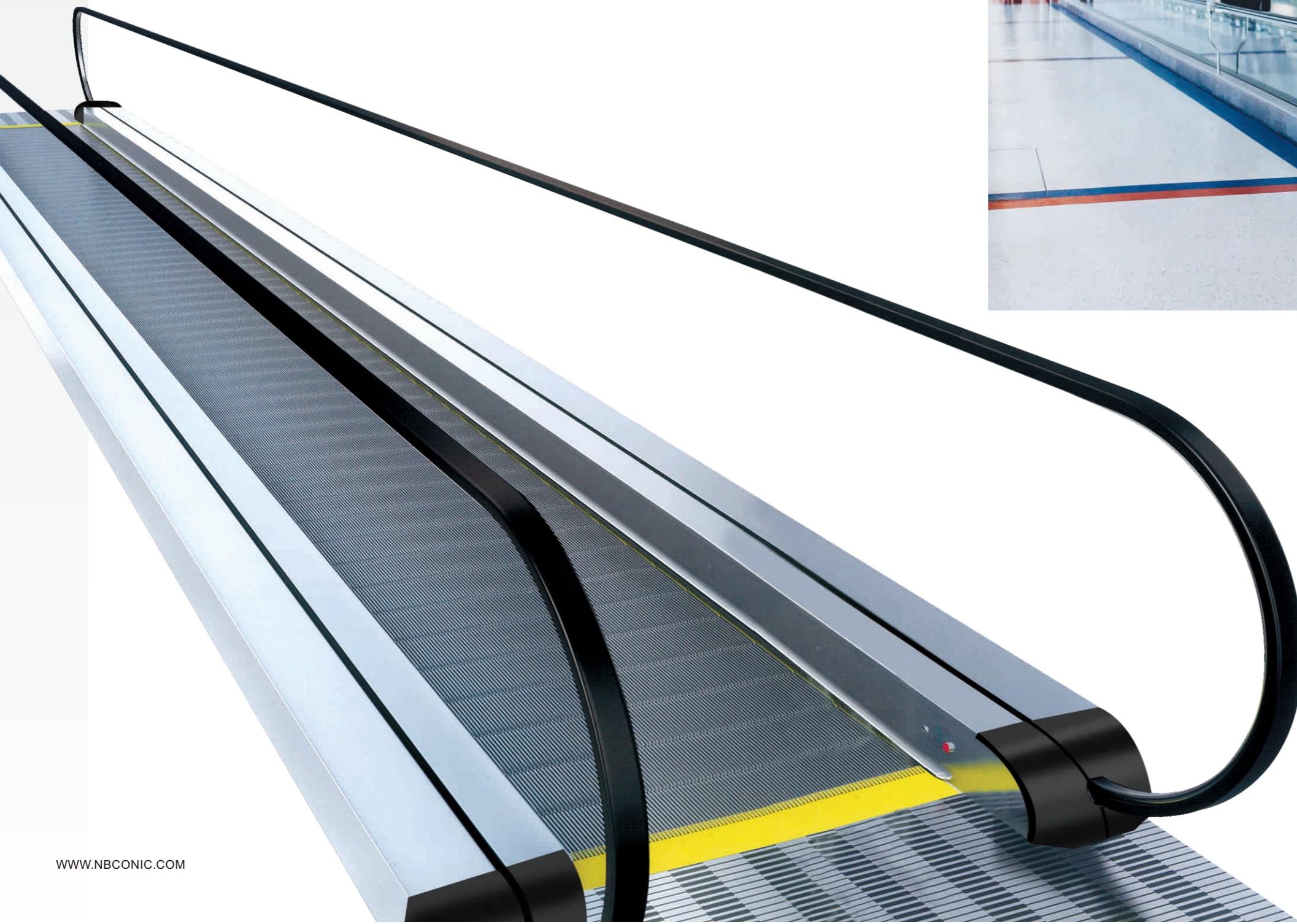

Special-purpose host

Complete safety protection functions, high drive efficiency, the more smooth running, the use of advanced technology conforms to engineering design.

Anti-skid slot design

Good anti-skid performance, ensure that the pedestrian walking process is unimpeded. When the frequency conversion specification runs, a variety of passenger flow methods are detected, and no one can stop automatically when unmanned. It avoids the invalid operation and saves electricity.



Comfort and safe

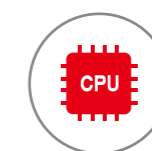

Intelligent computing



Remote monitoring